



UNIVERSIDAD NACIONAL AUTONOMA
DE MEXICO

5
25

CAMPUS ARAGON

REVISION DEL DISEÑO ESTRUCTURAL
DEL EDIFICIO DE REPRESENTACION
DEL INSTITUTO MEXICANO DEL PETROLEO
EN CIUDAD DEL CARMEN, CAMPECHE
(CUERPO B).

TESIS
QUE PARA OBTENER EL TITULO DE:
INGENIERO CIVIL

PRESENTA:
JOSE FERNANDO CANO SUAREZ

TESIS CON
FALLA DE ORIGEN

275885

1999



Universidad Nacional
Autónoma de México

Dirección General de Bibliotecas de la UNAM

Biblioteca Central



UNAM – Dirección General de Bibliotecas
Tesis Digitales
Restricciones de uso

DERECHOS RESERVADOS ©
PROHIBIDA SU REPRODUCCIÓN TOTAL O PARCIAL

Todo el material contenido en esta tesis esta protegido por la Ley Federal del Derecho de Autor (LFDA) de los Estados Unidos Mexicanos (México).

El uso de imágenes, fragmentos de videos, y demás material que sea objeto de protección de los derechos de autor, será exclusivamente para fines educativos e informativos y deberá citar la fuente donde la obtuvo mencionando el autor o autores. Cualquier uso distinto como el lucro, reproducción, edición o modificación, será perseguido y sancionado por el respectivo titular de los Derechos de Autor.



ESCUELA NACIONAL DE ESTUDIOS PROFESIONALES

ARAGÓN.

DIRECCION

UNIVERSIDAD NACIONAL
AUTÓNOMA DE
MÉXICO

JOSÉ FERNANDO CANO SUÁREZ
PRESENTE.

En contestación a la solicitud de fecha 13 de mayo del año en curso, relativa a la autorización que se le debe conceder para que el señor profesor, Ing. GUSTAVO ADOLFO JIMÉNEZ VILLEGAS pueda dirigirle el trabajo de tesis denominado, "REVISIÓN DEL DISEÑO ESTRUCTURAL DEL EDIFICIO DE REPRESENTACIÓN DEL INSTITUTO MEXICANO DEL PETRÓLEO EN CIUDAD DEL CARMEN, CAMPECHE (CUERPO B)", con fundamento en el punto 6 y siguientes, del Reglamento para Exámenes Profesionales en esta Escuela, y toda vez que la documentación presentada por usted reúne los requisitos que establece el precitado Reglamento; me permito comunicarle que ha sido aprobada su solicitud.

Aprovecho la ocasión para reiterarle mi distinguida consideración.

Atentamente
"POR MI RAZA HABLARA EL ESPÍRITU"
San Juan de Aragón, México, 21 de mayo de 1998

Lic. CARLOS EDUARDO LEVI VÁZQUEZ

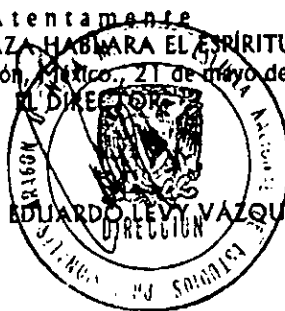

c c p Jefe de la Unidad Académica.
c c p Jefatura del Area de Ingeniería Civil.
c c p Asesor de Tesis.

CELV/AIR/MCA/11a.



**A MIS PADRES, JOSÉ Y LILÍA
POR DARME TODO SU APOYO Y CONSEJOS
A LO LARGO DE TODO ESTE TIEMPO
Y QUE ME HAN AYUDADO
A CONCLUIR CON ESTA CARRERA.**

**A MIS HERMANOS, ÓSCAR Y GERARDO
POR LA COMPAÑÍA Y CARÍÑO
QUE ME HAN BRINDADO.**

**A MIS MAMAS GRANDES, MARÍA Y REYNA
POR HABERME INCULCADO EL DESEO DE
SUPERACIÓN Y ESPERANDO SE SIENTAN
ORGULLOSAS.**





**A TODOS MIS MAESTROS Y PROFESORES,
QUE ME HAN ENSEÑADO Y QUE DE TODOS
SIEMPRE HAY ALGO QUE ME HA SIDO ÚTIL.**

**AGRADECIENDO TAMBIÉN AL INSTITUTO MEXICANO
DEL PETRÓLEO, POR LAS FACILIDADES OTORGADAS.**

A TODOS ¡GRACIAS!





INDICE

INTRODUCCIÓN	1
PLANTEAMIENTO DE LA ESTRUCTURA	3
CARACTERÍSTICAS DE LA ESTRUCTURA	3
ESTRUCTURA PROPUESTA	4
CIMENTACIÓN	5
DESCRIPCIÓN DE LA ESTRUCTURA	6
ANÁLISIS	7
CARGAS	7
ESPECIFICACIONES DE PROYECTO	8
REGLAMENTO DE APLICACIÓN	9
TIPO DE CONSTRUCCIÓN	9
TIPO DE SUELO DE UBICACIÓN	9
COEFICIENTE SÍSMICO	9
FACTOR DE DUCTILIDAD	10
DESPLAZAMIENTO HORIZONTAL PERMISIBLE	10
CONSTANTES DE CALCULO	10
FACTORES DE CALCULO	10
PROPIEDADES GEOMÉTRICAS DE ELEMENTOS	11





BAJADA DE CARGAS	12
PESOS UNITARIOS POR CONCEPTOS	13
PESO PROPIO DE COLUMNAS	17
PESO TRABES "T" Y DEL FIRME ESTRUCTURAL	20
SOBRECARGA MUERTA	21
CARGA VIVA MÁXIMA	24
CARGA VIVA ACCIDENTAL	26
CARGAS POR PLANTA	27
RESULTADOS	32
DISEÑO	43
DISEÑO DE COLUMNAS	43
DISEÑO DE TRABES	49
DISEÑO DE CONTRATRABES DE CIMENTACIÓN	68
DISEÑO DE MUROS DE CONCRETO	72
DISEÑO DE PLACAS	76
CONCLUSIONES	78
ANEXOS	82
BIBLIOGRAFÍA	





INTRODUCCION

UNO DE LOS ASPECTOS MÁS IMPORTANTES EN LOS QUE SE BASA UNA NUEVA CONSTRUCCIÓN ES SU DISEÑO; ¿ POR QUE SU DISEÑO?.

BUENO PUES DE LAS CUESTIONES PRIMORDIALES DE CUALQUIER CONSTRUCCIÓN ES QUE SU ESTRUCTURA SEA SEGURA PARA QUIEN HACE USO DE ELLA.

PARA PODER DECIR QUE UNA ESTRUCTURA ES SEGURA NOS TENEMOS QUE BASAR EN UN DISEÑO ESTRUCTURAL EL CUAL ESTÁ REALIZADO EN FUNCIÓN DEL USO QUE TENDRÁ NUESTRA ESTRUCTURA, LA CLASIFICACIÓN DE ÉSTA SEGÚN EL REGLAMENTO DE CONSTRUCCIONES DE LA ENTIDAD A LA QUE PERTENEZCA EL LUGAR DONDE SE CONSTRUIRÁ, LAS CARGAS QUE SE ENCONTRARAN PRESENTES DURANTE LA VIDA ÚTIL





DE LA CONSTRUCCIÓN Y ALGUNAS QUE SE PUEDEN PRESENTAR DE MANERA OCASIONAL COMO PUEDEN SER LOS SISMOS, LOS VIENTOS O ALGUNA EXPLOSIÓN DENTRO O FUERA DE NUESTRA ESTRUCTURA.

PARA PODER REALIZAR UN DISEÑO SE NECESITA CONTAR CON EL ANÁLISIS ESTRUCTURAL; EL CUAL NOS SIRVE PARA ENCONTRAR LOS ELEMENTOS MECANICOS PRINCIPALES QUE SE DEBEN UTILIZAR EN EL DISEÑO, COMO SON LAS FUERZAS DE COMPRESIÓN Y DE TENSIÓN, LAS FUERZAS ANTES MENCIONADAS SON EL RESULTADO DE LAS CARGAS QUE ACTÚAN SOBRE NUESTRA ESTRUCTURA DERIVÁNDOSE Y DESCOMPONIÉNDOSE.





PLANTEAMIENTO DE LA ESTRUCTURA

CARACTERÍSTICAS DE LA ESTRUCTURA

EL PROYECTO DE LA REPRESENTACIÓN DEL INSTITUTO MEXICANO DEL PETRÓLEO EN CIUDAD DEL CARMEN, CAMPECHE; SE ENCUENTRA FORMADO POR CUATRO CUERPOS.

CADA CUERPO TENDRÁ DIFERENTES ÁREAS DE TRABAJO, PUES SE TENDRÁN ÁREAS ADMINISTRATIVAS, DE INVESTIGACIÓN, DE SERVICIOS, DE INSTALACIONES, SALONES DE USOS MÚLTIPLES Y ESTACIONAMIENTOS.

LOS CUERPOS A Y B SE FORMARÁN DE UNA PLANTA BAJA Y UN PRIMER NIVEL, LOS EDIFICIOS C Y D ESTARÁN CONSTITUIDOS POR UNA PLANTA BAJA Y DOS NIVELES.

DEBIDO A LA MAGNITUD DE EL PROYECTO, EN ESTE TRABAJO SOLO SE REALIZARA LA REVISIÓN AL CUERPO B.

EL EDIFICIO B CONSTA DE 2 NIVELES, CON UNA DIMENSIÓN DE PLANTA DE 18 M POR 17 M.

LA ALTURA DEL ENTREPIESO DEL EDIFICIO B PARA PLANTA BAJA ES DE 4.8 M Y EL DE PRIMER NIVEL DE 3.73 M

LA LONGITUD DE LAS CRUJÍAS DEL EDIFICIO B SE ENCUENTRAN EN UN SENTIDO SON DE 3.66 M Y EN EL PERPENDICULAR DE ESTE DE 17M.

EL CUERPO B SE ENCUENTRA CONSTITUIDO POR:

EN SU PLANTA BAJA SE ENCONTRARA.- UN VESTÍBULO, DOS SANITARIOS Y CUATRO SALONES DE USOS MÚLTIPLES.

EN SU PRIMER NIVEL SE ALBERGARA.- UN VESTÍBULO, DOS SANITARIOS UNA SALA DE ESPERA, Y NUEVE OFICINAS LAS CUALES SERÁN OCUPADAS POR LAS GERENCIAS PRINCIPALES DE ESTA REPRESENTACIÓN DEL IMP.





ESTRUCTURA PROPUESTA

PARA ESTA ESTRUCTURA SE PROPONE EL USO DE ELEMENTOS PREFABRICADOS

SE HAN ELEGIDO LOS PREFABRICADOS DEBIDO A QUE EN ESTE SISTEMA DE CONSTRUCCIÓN SE MANTIENE UN ALTO CONTROL DE CALIDAD EN LA FABRICACIÓN DE ESTOS.

EN ESTE CONTROL DE CALIDAD SE VIGILA QUE:

EL MATERIAL QUE SE EMPLEA COMO AGREGADO PÉTREO SEA EL ADECUADO PARA SER USADO EN EL ELEMENTO ESTRUCTURAL, TOMANDO EN CUENTA SUS CONDICIONES DE TRABAJO, COMO SON EL TIPO DE CARGA Y LA ZONA GEOGRÁFICA EN LA QUE SE ENCUENTRA.

EL MATERIAL CEMENTANTE SEA EL ADECUADO PARA LA ZONA GEOGRÁFICA EN DONDE SE EMPLEARA EL ELEMENTO

EL ACERO DE REFUERZO SE ENCUENTRE EN BUEN ESTADO, CUMPLIENDO CON LA RESISTENCIA DESEADA PARA EL TRABAJO QUE REALIZARA, Y QUE SE ENCUENTRE BIEN DISTRIBUIDO DENTRO DE EL ELEMENTO ESTRUCTURAL

ASÍ COMO DE VIGILAR QUE LOS ADITIVOS QUE SE EMPLEARAN EN EL ELEMENTO SEAN LOS QUE SE NECESITAN Y QUE ESTOS SEAN COLOCADOS CON LA DOSIFICACIÓN QUE SE REQUIEREN Y EN LAS CONDICIONES EN QUE ESTOS REALIZAN SU MEJOR TRABAJO.

OTRO MOTIVO POR EL QUE SE ESCOGIÓ EL USO DE ELEMENTOS PREFABRICADOS SE DEBE A QUE SE PUEDE TRABAJAR DE UNA MANERA MÁS RÁPIDA, A ESTO SE LE PUEDE AGREGAR EL QUE NO SE REQUIERE DE MUCHA MANO DE OBRA ESPECIALIZADA PARA PODER REALIZAR EL MONTAJE DE ESTOS ELEMENTOS EN EL LUGAR QUE OCUPARAN DENTRO DE LA ESTRUCTURA.

ESTA ES UNA ENORME VENTAJA PUES EN LA ZONA EN LA QUE SE REALIZA LA CONSTRUCCIÓN SE CARECE DE LA MANO DE OBRA ESPECIALIZADA.

ADEMÁS DE QUE CON LA QUE SE CUENTA EN DICHO LUGAR ES UN TANTO PROBLEMÁTICA PUES DEBIDO AL CALOR QUE IMPERA EN LA ZONA EL RENDIMIENTO DE LOS TRABAJADORES ESTA POR DEBAJO DEL ESTÁNDAR; POR LO QUE AL USAR MATERIALES PREFABRICADOS SE ACORTA EL TIEMPO DE TRABAJO Y SE TIENE UN MAYOR AVANCE DE OBRA.





CON LO CUAL TAMBIÉN SE OBTIENE UN RELATIVO AHORRO ECONÓMICO EN COMPARACIÓN A QUE LOS ELEMENTOS DE LA ESTRUCTURA SE HUBIERAN CONSTRUIDO EN EL LUGAR.

LAS FACHADAS DEL CUERPO B SE RECUBRIRÁN TAMBIÉN CON ELEMENTOS PREFABRICADOS.

LA ESTRUCTURA SE REFORZARA CON MUROS ESTRUCTURALES COLADOS EN SITIO PARA DAR CONFINAMIENTO A DICHA ESTRUCTURA.

LA ESTRUCTURACIÓN DEL EDIFICIO B ES LA SIGUIENTE: LAS CARGAS GRAVITACIONALES SON SOPORTADAS EN UN SOLO SENTIDO, POR DOS MARCOS PARALELOS ENTRE SÍ, Y LAS CARGAS SÍSMICAS EN UN SOLO SENTIDO ESTÁN SOPORTADAS POR ESTOS MISMOS MARCOS Y EN EL OTRO POR LAS COLUMNAS QUE FORMAN LA ESTRUCTURA.

LAS COLUMNAS Y LAS TRABES, SON PREFABRICADAS; EL SISTEMA DE PISO ES PREFABRICADO Y PRESENTADO.

LAS COLUMNAS PREFABRICADAS TIENEN BRAZOS LOS CUALES TIENEN LA FUNCIÓN DE TRABES ENTRE COLUMNAS.

EXISTEN MUROS DE CONCRETO COLADOS EN SITIO EN EL SENTIDO TRANSVERSAL A LOS MARCOS FORMADOS POR LAS COLUMNAS.

EL SISTEMA DE PISO CONSISTE EN TRABES "T"; APOYADAS EN LAS TRABES QUE UNEN A LAS COLUMNAS.

SOBRE LAS TRABES "T" SE CUELA UN FIRME ESTRUCTURAL PARA CREAR UN DIAFRAGMA EN CADA NIVEL.

CIMENTACION

LA CIMENTACIÓN CONSISTE EN CONTRATRABES.

LOS PILOTES SON PREFABRICADOS; LA CIMENTACIÓN ES COLADA EN SITIO.

SOBRE LOS PILOTES SE COLOCARA UNA LOSA UNIDA A LAS CONTRATRABES PARA RECIBIR LAS COLUMNAS PREFABRICADAS O EN SU CASO SE DEJAN LAS VARILLAS DE COLUMNA ANCLADAS PARA LAS COLADAS EN SITIO.





LA CAPACIDAD DE CARGA DEL PILOTE CONSIDERA EN LA FRICCIÓN DE 85 ton/pilote Y EN LA PUNTA DE 170 ton/pilote, APROXIMADAMENTE.

DESCRIPCIÓN DE LA ESTRUCTURA

ESTA SE ENCUENTRA COMPUESTA POR DOCE COLUMNAS DE CONCRETO PRETENSADO, UBICADAS SEIS EN EL LADO ORIENTE Y OTRAS SEIS EN EL LADO PONIENTE DEL EDIFICIO. CON UNA ELEVACIÓN DE OCHO METROS CINCUENTA Y TRES CENTÍMETROS CADA COLUMNA.

LAS TRABES DE PLANTA BAJA SON DIEZ PIEZAS, LAS CUALES SON TRABES " T " DE CONCRETO PRESFORZADO, CON SU ALMA APOYADA EN LAS CONTRATRABES.

LAS TRABES DE PRIMER NIVEL Y AZOTEA TAMBIÉN SON DIEZ PIEZAS, LAS CUALES SON TRABES " T " DE CONCRETO PRESFORZADO, CON SU ALMA APOYADA EN LOS BRAZOS PORTANTES DE TRABES DE CADA COLUMNA.





ANÁLISIS

SE EFECTUÓ UN ANÁLISIS DE LA ESTRUCTURA SOMETIDA A CARGAS PERMANENTES, SOLAMENTE.

SE EFECTUÓ OTRO ANÁLISIS DE LA ESTRUCTURA SOMETIDA A CARGAS PERMANENTES MAS CARGAS ACCIDENTALES, EN ESTE CASO SISMO (QUE RESULTO MÁS DESFAVORABLE QUE EL EFECTO DE VIENTO).

PARA EL ANÁLISIS SÍSMICO SE UTILIZARON LOS MÉTODOS ESTÁTICO Y EL DINÁMICO CONTENIDOS EN LAS NORMAS TÉCNICAS COMPLEMENTARIAS PARA EL DISEÑO POR SISMO DE 1987, DEL REGLAMENTO DE CONSTRUCCIONES DEL DISTRITO FEDERAL.

PARA LA OBTENCIÓN DEL COEFICIENTE SÍSMICO DE LA ESTRUCTURA SE EMPLEO UN ESTUDIO DEL INSTITUTO DE INGENIERÍA Y LA SOCIEDAD MEXICANA DE INGENIERÍA SÍSMICA DE 1994.

LA ESTRUCTURA SE CLASIFICO, POR EL TIPO DE CONSTRUCCIÓN, DENTRO DEL GRUPO A. SE UBICO LA CONSTRUCCIÓN EN LA ZONA B (SEGÚN EL MAPA DE REGIONALIZACIÓN SÍSMICA DE MÉXICO) Y DENTRO DEL TIPO DE SUELO III.

DATOS SÍSMICOS CONSIDERADOS: COEFICIENTE SÍSMICO OBTENIDO ES $C_0 = 0.45$, FACTOR DE AMPLIFICACIÓN $F_A = 1.50$, COEFICIENTE SÍSMICO DE DISEÑO RESULTANTE $C = 0.68$.

POR EL COMPORTAMIENTO SÍSMICO DE LA ESTRUCTURA, EL FACTOR DE DUCTILIDAD EMPLEADO PARA AMBOS SENTIDOS FUE DE $Q = 2$.

SE UTILIZÓ EL PROGRAMA PARA ANÁLISIS ESTRUCTURAL EL CUAL EMPLEA EL MÉTODO DE LAS RIGIDECES.

CARGAS

SE CONSIDERAN LAS CARGAS PERMANENTES Y VARIABLES SEGÚN SE INDICA EN EL REGLAMENTO DE CONSTRUCCIONES DEL DISTRITO FEDERAL DE 1993, OBTENIÉNDOSE LOS SIGUIENTES VALORES PARA EL ANÁLISIS Y DISEÑO:

AZOTEAS:

CARGA MUERTA:

834 kg/m²

CARGA VIVA MÁXIMA:

100 kg/cm²



JOSE FERNANDO CANO SUAREZ



CARGA VIVA INSTANTÁNEA:	70 kg/cm ²
CARGA VIVA MEDIA:	15 kg/cm ²
ENTREPISOS:	
CARGA MUERTA:	614 kg/m ²
CARGA VIVA MÁXIMA:	250 kg/cm ²
CARGA VIVA INSTANTÁNEA:	180 kg/cm ²
CARGA VIVA MEDIA:	100 kg/cm ²

ESPECIFICACIONES DE PROYECTO

CONCRETO

CIMENTACION	$f_c = 250 \text{ kg./cm}^2$
COLUMNAS PREFABRICADAS	$f_c = 350 \text{ kg./cm}^2$
COLUMNAS COLADAS EN SITIO	$f_c = 350 \text{ kg./cm}^2$
TRABES COLADAS EN SITIO	$f_c = 250 \text{ kg./cm}^2$
TRABES "T"	$f_c = 350 \text{ kg./cm}^2$
FIRME ESTRUCTURAL Y COLADOS ADICIONALES	$f_c = 250 \text{ kg./cm}^2$

ACERO DE REFUERZO

ACERO $f_y = 4200 \text{ kg./cm}^2$

RECUBRIMIENTOS LIBRES

CIMENTACION	4.0 cm
COLUMNAS	4.0 cm
TRABES	2.0 cm
LOSAS	1.5 cm





REGLAMENTO DE APLICACION

ESTUDIOS DEL INSTITUTO DE INGENIERIA Y LA SOCIEDAD MEXICANA DE INGENIERIA SISMICA DE 1994.

REGLAMENTO DE CONSTRUCCIONES DEL DISTRITO FEDERAL DE 1993

TIPO DE CONSTRUCCION

LA ESTRUCTURA SE CLASIFICA POR EL TIPO DE CONSTRUCCION DENTRO DEL GRUPO A.

GRUPO A: EDIFICACIONES CUYA FALLA ESTRUCTURAL PODRIA CAUSAR LA PERDIDA DE UN ELEVADO NUMERO DE VIDAS O PERDIDAS ECONOMICAS O CULTURALES EXCEPCIONALMENTE ALTAS, O QUE CONSTITUYAN UN PELIGRO SIGNIFICATIVO POR CONTENER SUSTANCIAS TOXICAS O EXPLOSIVAS, ASI COMO EDIFICACIONES CUYO FUNCIONAMIENTO ES ESENCIAL A RAIZ DE UNA EMERGENCIA URBANA, COMO: HOSPITALES, ESCUELAS, TERMINALES DE TRANSPORTE, ESTACIONES DE BOMBEROS, CENTRALES ELECTRICAS Y DE TELECOMUNICACIONES; ESTADIOS, DEPOSITOS DE SUSTANCIAS INFLAMABLES O TOXICAS; MUSEOS Y EDIFICIOS QUE ALOJEN ARCHIVOS Y REGISTROS PUBLICOS DE PARTICULAR IMPORTANCIA, A JUICIO DEL DEPARTAMENTO.

TIPO DE SUELO DE UBICACION

LA ESTRUCTURA SE LOCALIZA EN LA ZONA B, SEGÚN MAPA DE REGIONALIZACION SISMICA DE MEXICO. EL SUELO ES DE TIPO III.

COEFICIENTE SISMICO

EL COEFICIENTE SISMICO QUE LE CORRESPONDE POR LA ZONA ES:

$$\begin{aligned}cc &= 0.45 \\fa &= 1.5 \\C = (fa)(cc) &= 0.68\end{aligned}$$



JOSE FERNANDO CANO SUAREZ



FACTOR DE DUCTILIDAD

POR EL COMPORTAMIENTO SISMICO DE LA ESTRUCTURA EL FACTOR DE DUCTILIDAD A CONSIDERAR PARA AMBOS SENTIDOS ES: $Q = 2.0$

DESPLAZAMIENTO HORIZONTAL PERMISIBLE

EL DESPLAZAMIENTO HORIZONTAL SERA:

$$D_{perm} = 0.006 H$$

H de entrepiso

CONSTANTES DE CALCULO

CONCRETO CLASE 1 DE:

$$\begin{aligned}
 f_c &= 350 \text{ kg./cm}^2 & f''_c &= 0.85f_c = 297.5 \text{ kg./cm}^2 \\
 E_c &= 14000(f_c)^{1/2} = 261916 \text{ kg./cm}^2 & p_{min} &= ((0.7(f_c)^{1/2})/f_y) = \\
 G &= 0.4E_c = 104766 \text{ kg./cm}^2 & & \\
 f^*_c &= 0.8f_c = 280 \text{ kg./cm}^2 & p_{max} &= 0.75(f''_c/f_y)(4800/(6000+f_y)) = 0.019435 \\
 & & & 0.003118
 \end{aligned}$$

FACTORES DE CALCULO

FACTOR DE CARGA

$$\begin{aligned}
 \text{F/ACC. PERMANENTES} & \quad FC_p = 1.4 \\
 \text{F/ACC. ACCIDENTALES} & \quad FC_p = 1.1
 \end{aligned}$$

FACTOR DE RESISTENCIA



JOSE FERNANDO CANO SUAREZ



FLEXION	0.8
CORTANTE	0.8
TORSIÓN	0.8
FLEXOCOMPRESION	0.8

PROPIEDADES GEOMETRICAS DE LOS ELEMENTOS

ELEMENTO C1 (COLUMNAS)

B = 50.00 cm	=	0.5000 m
H = 50.00 cm	=	0.5000 m
A = 2500.00 cm ²	=	0.2500 m ²
Yc = 25.00 cm	=	0.2500 m
Zc = 25.00 cm	=	0.2500 m
Ixc = 520833.3 cm ⁴	=	0.0052 m ⁴
Izc = 520833.3 cm ⁴	=	0.0052 m ⁴
E (350) = 2619160		

ELEMENTO T1 (TRABES DE ENTREPISOS)

B = 50.00 cm	=	0.5000 m
H = 50.00 cm	=	0.5000 m
A = 2500.00 cm ²	=	0.2500 m ²
Xc = 25.00 cm	=	0.2500 m
Yc = 25.00 cm	=	0.2500 m
Ixc = 520833.3 cm ⁴	=	0.0052 m ⁴
Iyc = 520833.3 cm ⁴	=	0.0052 m ⁴
Itors = 770833.3 cm ⁴	=	0.0077 m ⁴
E (350) = 2619160		

ELEMENTO T3 (CONTRATRABES DE CIMENTACION)

B = 50.00 cm	=	0.5000 m
H = 120.00 cm	=	1.2000 m
A = 6000.00 cm ²	=	0.6000 m ²
Xc = 25.00 cm	=	0.2500 m
Yc = 60.00 cm	=	0.6000 m
Ixc = 7200000 cm ⁴	=	0.0720 m ⁴
Iyc = 1250000 cm ⁴	=	0.0125 m ⁴
Itors = 3687500 cm ⁴	=	0.0369 m ⁴
E (250) = 2213590		





BAJADA DE CARGAS.

BAJADA DE CARGAS

CARGAS UNITARIAS

CARGA
MUERTA

PESO DE MATERIALES

CONCEPTO	PESO UNITARIO
CONCRETO ARMADO	2.40 ton/m ³
MORTERO	2.00 ton/m ³
SUELO EXISTENTE	1.60 ton/m ²
SUELO DE RELLENO	1.60 ton/m ²
RELLENO (TEZONTLE)	1.20 ton/m ²
TABIQUE MACIZO	1.40 ton/m ²
PIEDRA BRAZA	2.50 ton/m ²
TIERRA PARA JARDINERIA	1.60 ton/m ²
MURO DE TABIQUE RECOCIDO. JUNTEADO. APLANADO (12e)	0.25 ton/m ²
MURO DE TABLAROCA (10e)	0.03 ton/m ²
FACHADAS PRECOLADAS (10e)	0.22 ton/m ²
VENTANAS	0.05 ton/m ²
PISOS	0.06 ton/m ²
INSTALACIONES Y RECUBRIMIENTOS	0.04 ton/m ²
PESO DE PANEL COVITEC	0.01 ton/m ²
PESO ADICIONAL EN LOSAS. SEGÚN R.D.F. 93	0.02 ton/m ²
LAMINA DELGADA	0.01 ton/m ²
TUBO DE 10"	0.015 ton/m
PTR 4"	0.015 ton/m
MAQUINA MAS PESADA DEL AIRE ACONDICIONADO	2.5 ton





PESOS UNITARIOS POR CONCEPTOS

[*] ton. ton/m² . ton/m²[**] ton. ton/m . ton/m²

CONCEPTO	Wmat [*]	A m o m ²	H m	Wtotal ton	LO # m o sin	Wu [**]
MURO ESTRUCTURAL Y DE FACHADA						
MURO ESTRUCTURAL	2.400	1	0.200	0.480	1	0.480
MURO DE TABLAROCA	0.030	1	1.000	0.030	1	0.030
ACABADO	2.000	1	0.030	0.060	1	0.060
ton/m ²				0.570		0.570
MURO FACHADA						
PRECOLADO	0.220	1	1.000	0.220	1	0.220
MURO DE TABLAROCA	0.030	1	1.000	0.030	1	0.030
ton/m ²				0.250		0.250
MURO TABIQUE DE FACHADA						
ACABADO	2.000	1	0.030	0.060	1	0.060
MURO DE TABIQUE	0.250	1	1.000	0.250	1	0.250
ton/m ²				0.310		0.310
MURO PRETEL DE FACHADA H = 310						
PRECOLADO MURO	0.220	1	3.600	0.792	1	0.792
MURO DE TABLAROCA	0.030	1	3.100	0.093	1	0.093
ton/m ²				0.885		0.885
MURO PRETEL DE FACHADA H = 172						
PRECOLADO MURO	0.220	1	1.720	0.378	1	0.378
MURO DE TABLAROCA	0.030	1	1.720	0.052	1	0.052
ton/m ²				0.430		0.430
MURO ESTRUCTURAL DE FACHADA H = 373						
MURO	0.570	1	3.730	2.126	1	2.126
ton/m ²				2.126		2.126





MURO ESTRUCTURAL DE FACHADA H = 480						
MURO	0.570	1	4.800	2.736	1	2.736
ton/m ²				2.736		2.736
MURO PRECOLADO DE FACHADA H = 373						
MURO	0.310	1	3.730	1.156	1	1.156
ton/m ²				1.156		1.156
MURO PRECOLADO DE FACHADA H = 480						
MURO	0.310	1	4.800	1.488	1	1.488
ton/m ²				1.488		1.488
PRECOLADOS DE FACHADA H = 480						
MURO	0.250	1	4.800	1.200	1	1.200
ton/m ²				1.200		1.200
PRECOLADOS DE FACHADA H = 201						
MURO	0.250	1	2.010	0.503	1	0.503
ton/m ²				0.503		0.503
CANCELERIA H = 373						
VENTANAS	0.050	1	3.730	0.187	1	0.187
ton/m ²				0.187		0.187
CANCELERIA H = 480						
VENTANAS	0.050	1	4.800	0.240	1	0.240
ton/m ²				0.240		0.240
DENSIDAD D/MUROS P.B.						
MUROS DE TABIQUE	0.250	16.8	3.900	16.380	62.2	0.263
ton/m ²				16.380		0.263
DENSIDAD D/MUROS N.1.						
MUROS DE TABIQUE	0.250	17.4	3.030	13.181	62.22	0.212
ton/m ²				13.181		0.212
DENSIDAD D/MAQUINAS AZOT.						
MAQUINAS	3.400	1	1.000	3.400	124.44	0.027
ton/m ²				3.400		0.027
TRABES "T" B=181						





PATINES DE "T"	2.4	0.2	16.54	7.939	17.08	0.465
ALMAS DE "T"	2.400	0.13	16.830	5.251	17.08	0.307
ton/m				13.190		0.772
SISTEMA DE LOSA B = 181						
TRABES "T"	0.767	17.08	2	26.201	66.9	0.392
FIRME ESTRUCTURAL	2.4	0.183	17.560	7.721	66.9	0.115
C.M. ADIC (RDF)	0.020	1	17.580	0.352	66.9	0.005
ton/m				34.273		0.512
LOSA COLADA EN SITIO H = 10						
LOSA	2.4	1	0.1	0.240	1	0.240
C.M. ADIC (RDF)	0.020	1	1.000	0.020	1	0.020
ton/m				0.260		0.260
TRABE PORTANTE H = 50						
TRABE	2.4	0.5	0.5	0.600	1	0.600
ton/m				0.600		0.600
COLUMNA 50x50						
COLUMNA	2.4	0.5	0.5	0.600	1	0.600
ton/m				0.600		0.600
CONTRATRABE 25x50						
COLUMNA	2.4	0.25	1.2	0.720	1	0.720
ton/m				0.720		0.720

CONCEPTO	Wmat *	A m o m2	H m	Wtotal ton	L o # m o SIN	Wu **
SOBRECARGA MUERTA EN LOSA DE AZOTEA (OFICINAS Y BAÑOS)						
MORTERO	2.00	1.00	0.02	0.04	1.00	0.040
ENLADRILLADO	1.40	1.00	0.02	0.03	1.00	0.028
ENTORTADO	2.00	1.00	0.03	0.06	1.00	0.060
RELLENO	1.20	1.00	0.16	0.19	1.00	0.192
INSTAL Y RECUBR	0.04	1.00	1.00	0.04	1.00	0.040
C.M. ADIC. (RDF)	0.02	1.00	1.00	0.02	1.00	0.020





ton/m ²				0.38		0.380
--------------------	--	--	--	------	--	-------

SOBRECARGA MUERTA EN LOSA DE AZOTEA (ZONA

D/MAQUINAS)

MORTERO	2.00	1.00	0.02	0.04	1.00	0.040
ENLADRILLADO	1.40	1.00	0.02	0.03	1.00	0.028
ENTORTADO	2.00	1.00	0.03	0.06	1.00	0.060
RELLENO	1.20	1.00	0.16	0.19	1.00	0.192
INSTAL Y RECUBR	0.04	1.00	1.00	0.04	1.00	0.040
DENSIDAD D/MAQ	0.03	1.00	1.00	0.03	1.00	0.027
C.M. ADIC. (RDF)	0.02	1.00	1.00	0.02	1.00	0.020

ton/m ²				0.41		0.407
--------------------	--	--	--	------	--	-------

SOBRECARGA MUERTA EN LOSA DE ENTREPISO (OFICINAS)

PISO	0.06	1.00	1.00	0.06	1.00	0.060
MORTERO	2.00	1.00	0.02	0.04	1.00	0.040
INSTAL Y RECUBR	0.04	1.00	1.00	0.04	1.00	0.040
C.M. ADIC. (RDF)	0.02	1.00	1.00	0.02	1.00	0.020

ton/m ²				0.16		0.160
--------------------	--	--	--	------	--	-------

SOBRECARGA MUERTA EN LOSA DE ENTREPISO (BAÑOS N.1)

PISO	0.06	1.00	1.00	0.06	1.00	0.060
MORTERO	2.00	1.00	0.02	0.04	1.00	0.040
INSTAL Y RECUBR	0.04	1.00	1.00	0.04	1.00	0.040
DENSIDAD DE MUROS	0.21	1.00	1.00	0.21	1.00	0.212
C.M. ADIC. (RDF)	0.02	1.00	1.00	0.02	1.00	0.020

ton/m ²				0.372		0.372
--------------------	--	--	--	-------	--	-------

SOBRECARGA MUERTA EN LOSA DE ENTREPISO (BAÑOS P.B.)

PISO	0.06	1.00	1.00	0.06	1.00	0.060
MORTERO	2.00	1.00	0.02	0.04	1.00	0.040
INSTAL Y RECUBR	0.04	1	1	0.04	1.00	0.040
DENSIDAD D/MAQ	0.263	1	1	0.263	1.00	0.263
C.M. ADIC. (RDF)	0.02	1	1	0.02	1.00	0.020

ton/m ²				0.423		0.423
--------------------	--	--	--	-------	--	-------

NOMENCLATURA

W_{mat}PESO UNITARIO DEL MATERIAL DEL
CONCEPTO

A

AREA O ANCHO DEL ELEMENTO
CONSIDERADO

H

LONGITUD O ALTURA DEL
ELEMENTOW_{total}

PESO TOTAL DEL CONCEPTO CONSIDERADO





L o # LONGITUD O NUMERO, EN EL QUE SE DIVIDE EL PESO TOTAL PARA
OBTENER EL PESO UNITARIO.

Wu PESO UNITARIO DEL CONCEPTO

FORMULARIO

$$W_{total} = A \times H \times W_{mat}$$

$$W_u = W_{total} / L$$

CONCEPTO	CARGA VIVA	PESO UNITARIO	PESO UNITARIO
		kg/m ²	ton/m ²
AZOTEA	MAXIMA	100	0.1
	ACCIDENTAL	70	0.07
	MEDIA	15	0.015
ENTREPISO	MAXIMA	250	0.25
	ACCIDENTAL	180	0.18
	MEDIA	100	0.1

PESO PROPIO DE COLUMNAS.CARGAS EN
ELEMENTOS

EJE	NIVEL	CRUJIA	W _a	W	Lo	WE
			ton/m	ton/m	m	ton
15	AZOT	F-G	0.6	0.6	3.66	2.20
		G-J	0.6	0.6	3.66	2.20
		J-K	0.6	0.6	3.66	2.20
		K-M	0.6	0.6	3.66	2.20
		M-N	0.6	0.6	3.66	2.20
	1ER	F-G	0.6	0.6	3.66	2.20
		G-J	0.6	0.6	3.66	2.20
		J-K	0.6	0.6	3.66	2.20
		K-M	0.6	0.6	3.66	2.20
		M-N	0.6	0.6	3.66	2.20
	P.B.	F-G	1.44	1.44	3.66	5.27





		G-J	1.44	1.44	3.66	5.27
		J-K	1.44	1.44	3.66	5.27
		K-M	1.44	1.44	3.66	5.27
		M-N	1.44	1.44	3.66	5.27
21	AZOT	F-G	0.6	0.6	3.66	2.20
		G-J	0.6	0.6	3.66	2.20
		J-K	0.6	0.6	3.66	2.20
		K-M	0.6	0.6	3.66	2.20
		M-N	0.6	0.6	3.66	2.20
	1ER	F-G	0.6	0.6	3.66	2.20
		G-J	0.6	0.6	3.66	2.20
		J-K	0.6	0.6	3.66	2.20
		K-M	0.6	0.6	3.66	2.20
		M-N	0.6	0.6	3.66	2.20
	P.B.	F-G	1.44	1.44	3.66	5.27
		G-J	1.44	1.44	3.66	5.27
		J-K	1.44	1.44	3.66	5.27
		K-M	1.44	1.44	3.66	5.27
		M-N	1.44	1.44	3.66	5.27
F	AZOT	15-IZQ	0	0	4.24	0.00
		IZQ-DER	0	0	12.84	0.00
		DER-21	0	0	4.24	0.00
	1ER	15-IZQ	0	0	4.24	0.00
		IZQ-DER	0	0	12.84	0.00
		DER-21	0	0	4.24	0.00
	P.B.	15-IZQ	0	0	4.24	0.00
		IZQ-DER	0	0	12.84	0.00
		DER-21	0	0	4.24	0.00
N	AZOT	15-IZQ	0	0	4.24	0.00
		IZQ-DER	0	0	12.84	0.00
		DER-21	0	0	4.24	0.00
	1ER	15-IZQ	0	0	4.24	0.00
		IZQ-DER	0	0	12.84	0.00
		DER-21	0	0	4.24	0.00
	P.B.	15-IZQ	0	0	4.24	0.00
		IZQ-DER	0	0	12.84	0.00
		DER-21	0	0	4.24	0.00
G.J.K.M	AZOT	15-21	0	0	17.08	0.00
	1ER	15-21	0	0	17.08	0.00
	PB	15-21	0	0	17.08	0.00





CARGAS EN NUDOS

EJE	NIVEL	EJES	L	W _e	P	#	WE
			m	ton/m	ton	SIN	ton
15	AZOT	F	0	0	0	0	0
		G	0	0	0	0	0
		J	0	0	0	0	0
		K	0	0	0	0	0
		M	0	0	0	0	0
		N	0	0	0	0	0
	1ER	F	3.73	0.6	2.238	1	2.238
		G	3.73	0.6	2.238	1	2.238
		J	3.73	0.6	2.238	1	2.238
		K	3.73	0.6	2.238	1	2.238
		M	3.73	0.6	2.238	1	2.238
		N	3.73	0.6	2.238	1	2.238
	P.B.	F	6	0.6	3.6	1	3.6
		G	6	0.6	3.6	1	3.6
		J	6	0.6	3.6	1	3.6
		K	6	0.6	3.6	1	3.6
		M	6	0.6	3.6	1	3.6
		N	6	0.6	3.6	1	3.6
21	AZOT	F	0	0	0	0	0
		G	0	0	0	0	0
		J	0	0	0	0	0
		K	0	0	0	0	0
		M	0	0	0	0	0
		N	0	0	0	0	0
	1ER	F	3.73	0.6	2.238	1	2.238
		G	3.73	0.6	2.238	1	2.238
		J	3.73	0.6	2.238	1	2.238
		K	3.73	0.6	2.238	1	2.238
		M	3.73	0.6	2.238	1	2.238
		N	3.73	0.6	2.238	1	2.238
	P.B.	F	6	0.6	3.6	1	3.6
		G	6	0.6	3.6	1	3.6
		J	6	0.6	3.6	1	3.6





K	6	0.6	3.6	1	3.6
M	6	0.6	3.6	1	3.6
N	6	0.6	3.6	1	3.6

PESO TRABES "T" Y DEL FIRME ESTRUCTURAL.

CARGAS EN ELEMENTOS

EJE	NIVEL	CRUJIA	Lo#	A	We	P	WE
			m o SIN	m ²	ton/m ²	ton	ton
15	AZOT	F-G	2	38.91	0.512	9.46	18.90
		G-J	2	34.55	0.512	8.85	17.69
		J-K	2	34.55	0.512	8.85	17.69
		K-M	2	34.55	0.512	8.85	17.69
		M-N	2	40.69	0.512	10.43	20.83
	1ER	F-G	2	34.37	0.512	8.81	17.60
		G-J	2	32.17	0.512	8.24	16.47
		J-K	2	32.17	0.512	8.24	16.47
		K-M	2	32.17	0.512	8.24	16.47
		M-N	2	32.17	0.512	8.24	16.47
	P.B.	F-G	2	38.94	0.512	9.98	19.94
		G-J	2	33.45	0.512	8.57	17.13
		J-K	2	33.45	0.512	8.57	17.13
		K-M	2	33.45	0.512	8.57	17.13
		M-N	2	38.94	0.512	9.98	19.94
21	AZOT	F-G	2	38.91	0.512	9.46	18.90
		G-J	2	34.55	0.512	8.85	17.69
		J-K	2	34.55	0.512	8.85	17.69
		K-M	2	34.55	0.512	8.85	17.69
		M-N	2	40.69	0.512	10.43	20.83
	1ER	F-G	2	34.37	0.512	8.81	17.60
		G-J	2	32.17	0.512	8.24	16.47
		J-K	2	32.17	0.512	8.24	16.47
		K-M	2	32.17	0.512	8.24	16.47
		M-N	2	32.17	0.512	8.24	16.47
	P.B.	F-G	2	38.94	0.512	9.98	19.94
		G-J	2	33.45	0.512	8.57	17.13
		J-K	2	33.45	0.512	8.57	17.13





		K-M	2	33.45	0.512	8.57	17.13
		M-N	2	38.94	0.512	9.88	19.94
F	AZOT	15-IZQ	1	0	0	0	0.00
		IZQ-DER	1	0	0	0	0.00
		DER-21	1	0	0	0	0.00
	1ER	15-IZQ	1	0	0	0	0.00
		IZQ-DER	1	0	0	0	0.00
		DER-21	1	0	0	0	0.00
	P.B.	15-IZQ	1	0	0	0	0.00
		IZQ-DER	1	0	0	0	0.00
		DER-21	1	0	0	0	0.00
N	AZOT	15-IZQ	1	0	0	0	0.00
		IZQ-DER	1	0	0	0	0.00
		DER-21	1	0	0	0	0.00
	1ER	15-IZQ	1	0	0	0	0.00
		IZQ-DER	1	0	0	0	0.00
		DER-21	1	0	0	0	0.00
	P.B.	15-IZQ	1	0	0	0	0.00
		IZQ-DER	1	0	0	0	0.00
		DER-21	1	0	0	0	0.00
G.J.K.M	AZOT	15-21	1	0	0	0	0.00
	1ER	15-21	1	0	0	0	0.00
	PB	15-21	1	0	0	0	0.00

SOBRECARGA MUERTA.

CARGAS EN ELEMENTOS

EJE	NIVEL	CRUJIA	#P	L	A	Wa	Wl
			SIN	m	m ²	ton/m ²	ton/m
15	AZOT	F-G	2	3.66	36.91	0.447	0.885
		G-J	2	3.66	34.55	0.407	0.885
		J-K	2	3.66	34.55	0.380	0.885
		K-M	2	3.66	34.55	0.380	0.885
		M-N	2	3.66	40.69	0.461	0.885
	1ER	F-G	2	3.66	34.37	0.160	1.788
		G-J	2	3.66	32.17	0.160	0.187
		J-K	2	3.66	32.17	0.372	0.187





		K-M	2	3.66	32.17	0.372	0.187
		M-N	2	3.66	32.17	0.160	1.939
	P.B.	F-G	2	3.66	38.94	0.423	2.865
		G-J	2	3.66	33.45	0.160	1.488
		J-K	2	3.66	33.45	0.160	0.240
		K-M	2	3.66	33.45	0.160	1.488
		M-N	2	3.66	38.94	0.160	3.350
21	AZOT	F-G	2	3.66	38.91	0.447	0.885
		G-J	2	3.66	34.55	0.407	0.885
		J-K	2	3.66	34.55	0.380	0.885
		K-M	2	3.66	34.55	0.380	0.885
		M-N	2	3.66	40.69	0.481	0.885
	1ER	F-G	2	3.66	34.37	0.160	1.788
		G-J	2	3.66	32.17	0.160	0.187
		J-K	2	3.66	32.17	0.372	0.187
		K-M	2	3.66	32.17	0.372	0.187
		M-N	2	3.66	32.17	0.160	1.939
	P.B.	F-G	2	3.66	38.94	0.423	2.865
		G-J	2	3.66	33.45	0.160	1.488
		J-K	2	3.66	33.45	0.160	0.240
		K-M	2	3.66	33.45	0.160	1.488
		M-N	2	3.66	38.94	0.160	3.350
F	AZOT	15-IZQ	0	2.75	0	0	0.430
		IZQ-DER	0	11.58	0	0	0.000
		DER-21	0	2.75	0	0	0.430
	1ER	15-IZQ	0	2.75	0	0	2.128
		IZQ-DER	0	11.58	0	0	0.000
		DER-21	0	2.75	0	0	2.128
	P.B.	15-IZQ	0	4.24	0	0	2.736
		IZQ-DER	0	12.84	0	0	0.000
		DER-21	0	4.24	0	0	2.736
N	AZOT	15-IZQ	0	2.75	0	0	0.430
		IZQ-DER	0	11.58	0	0	0.000
		DER-21	0	2.75	0	0	0.430
	1ER	15-IZQ	0	2.75	0	0	2.128
		IZQ-DER	0	11.58	0	0	0.000
		DER-21	0	2.75	0	0	2.128
	P.B.	15-IZQ	0	4.24	0	0	2.736
		IZQ-DER	0	12.84	0	0	0.000
		DER-21	0	4.24	0	0	2.736
G.J.K.M	AZOT	15-21	0	17.08	0	0	0.000





	1ER	15-21	0	17.08	0	0	0.000
	PB	15-21	0	17.08	0	0	0.000
EJE	NIVEL	CRUJIA	W	P	Lo	#	WE
			ton/m	ton	m	SIN	ton
15	AZOT	F-G	0.89	8.25	3.66	2	19.74
		G-J	0.89	7.03	3.66	2	17.30
		J-K	0.89	6.56	3.66	2	16.36
		K-M	0.89	8.56	3.66	2	16.36
		M-N	0.89	9.39	3.66	2	22.02
	1ER	F-G	1.79	2.75	3.66	2	12.04
		G-J	0.19	2.57	3.66	2	5.82
		J-K	0.19	5.98	3.66	2	12.64
		K-M	0.19	5.98	3.66	2	12.64
		M-N	1.94	2.57	3.66	2	12.24
	P.B.	F-G	2.87	8.24	3.66	2	26.97
		G-J	1.49	2.68	3.66	2	10.81
		J-K	0.24	2.68	3.66	2	6.24
		K-M	1.49	2.68	3.66	2	10.81
		M-N	3.35	3.12	3.66	2	18.50
21	AZOT	F-G	0.89	8.25	3.66	2	19.74
		G-J	0.89	7.03	3.66	2	17.30
		J-K	0.89	6.56	3.66	2	16.36
		K-M	0.89	6.56	3.66	2	16.36
		M-N	0.89	9.39	3.66	2	22.02
	1ER	F-G	1.79	2.75	3.66	2	12.04
		G-J	0.19	2.57	3.66	2	5.82
		J-K	0.19	5.98	3.66	2	12.64
		K-M	0.19	5.98	3.66	2	12.64
		M-N	1.94	2.57	3.66	2	12.24
	P.B.	F-G	2.87	8.24	3.66	2	26.97
		G-J	1.49	2.68	3.66	2	10.81
		J-K	0.24	2.68	3.66	2	6.24
		K-M	1.49	2.68	3.66	2	10.81
		M-N	3.35	3.12	3.66	2	18.50
F	AZOT	15-IZQ	0.43	0	2.75	0	1.18
		IZQ-DER	0.00	0	11.58	0	0.00
		DER-21	0.43	0	2.75	0	1.18
	1ER	15-IZQ	2.13	0	2.75	0	5.85
		IZQ-DER	0.00	0	11.58	0	0.00
		DER-21	2.13	0	2.75	0	5.85





N	P.B.	15-IZQ	2.74	0	4.24	0	11.60	
		IZQ-DER	0.00	0	12.84	0	0.00	
		DER-21	2.74	0	4.24	0	11.60	
	AZOT	15-IZQ	0.43	0	2.75	0	1.18	
		IZQ-DER	0.00	0	11.58	0	0.00	
		DER-21	0.43	0	2.75	0	1.18	
	1ER	15-IZQ	2.13	0	2.75	0	5.85	
		IZQ-DER	0.00	0	11.58	0	0.00	
		DER-21	2.13	0	2.75	0	5.85	
G.J.K.M	P.B.	15-IZQ	2.74	0	4.24	0	11.60	
		IZQ-DER	0.00	0	12.84	0	0.00	
		DER-21	2.74	0	4.24	0	11.60	
	AZOT	15-21	0.00	0	68.32	0	0.00	
		1ER	15-21	0.00	0	68.32	0	0.00
		PB	15-21	0.00	0	68.32	0	0.00

$$WE = W Lo + P\#$$

CARGAS EN NUDOS

EJE	NIVEL	EJES	L	We	P	#	WE
			m	ton/m	ton	SIN	ton
F	AZOT	15	1	7.110	7.11	1	7.11
		21	1	19.50	19.5	1	19.50

CARGA VIVA MÁXIMA.

CARGAS EN ELEMENTOS

EJE	NIVEL	CRUJIA	L o #	A	W	P	WE
			m o SIN	m ²	ton/m ²	ton	ton
15	AZOT	F-G	2.00	36.91	0.10	1.846	3.69
		G-J	2.00	34.55	0.10	1.728	3.46
		J-K	2.00	34.55	0.10	1.728	3.46
		K-M	2.00	34.55	0.10	1.728	3.46
		M-N	2.00	40.69	0.10	2.035	4.07
	1ER	F-G	2.00	34.37	0.25	4.296	8.59
		G-J	2.00	32.17	0.25	4.021	8.04
		J-K	2.00	32.17	0.25	4.021	8.04
		K-M	2.00	32.17	0.25	4.021	8.04





		M-N	2.00	32.17	0.25	4.021	8.04
	P.B.	F-G	2.00	38.94	0.25	4.868	9.74
		G-J	2.00	33.45	0.25	4.181	8.36
		J-K	2.00	33.45	0.25	4.181	8.36
		K-M	2.00	33.45	0.25	4.181	8.36
		M-N	2.00	38.94	0.25	4.868	9.74
21	AZOT	F-G	2.00	36.91	0.10	1.846	3.69
		G-J	2.00	34.55	0.10	1.728	3.46
		J-K	2.00	34.55	0.10	1.728	3.46
		K-M	2.00	34.55	0.10	1.728	3.46
		M-N	2.00	40.69	0.10	2.035	4.07
	1ER	F-G	2.00	34.37	0.25	4.296	8.59
		G-J	2.00	32.17	0.25	4.021	8.04
		J-K	2.00	32.17	0.25	4.021	8.04
		K-M	2.00	32.17	0.25	4.021	8.04
		M-N	2.00	32.17	0.25	4.021	8.04
	P.B.	F-G	2.00	38.94	0.25	4.868	9.74
		G-J	2.00	33.45	0.25	4.181	8.36
		J-K	2.00	33.45	0.25	4.181	8.36
		K-M	2.00	33.45	0.25	4.181	8.36
		M-N	2.00	38.94	0.25	4.868	9.74
F	AZOT	15-IZQ	2.75	0.00	0.10	0.000	0.00
		IZQ-DER	11.58	0.00	0.10	0.000	0.00
		DER-21	2.75	0.00	0.10	0.000	0.00
	1ER	15-IZQ	2.75	0.00	0.25	0.000	0.00
		IZQ-DER	11.58	0.00	0.10	0.000	0.00
		DER-21	2.75	0.00	0.25	0.000	0.00
	P.B.	15-IZQ	4.24	0.00	0.10	0.000	0.00
		IZQ-DER	12.84	0.00	0.25	0.000	0.00
		DER-21	4.24	0.00	0.10	0.000	0.00
N	AZOT	15-IZQ	2.75	0.00	0.10	0.000	0.00
		IZQ-DER	11.58	0.00	0.10	0.000	0.00
		DER-21	2.75	0.00	0.10	0.000	0.00
	1ER	15-IZQ	2.75	0.00	0.25	0.000	0.00
		IZQ-DER	11.58	0.00	0.10	0.000	0.00
		DER-21	2.75	0.00	0.25	0.000	0.00
	P.B.	15-IZQ	4.24	0.00	0.10	0.000	0.00
		IZQ-DER	12.84	0.00	0.25	0.000	0.00
		DER-21	4.24	0.00	0.10	0.000	0.00
G.J.K.M	AZOT	15-21	17.08	0.00	0.10	0.000	0.00
	1ER	15-21	17.08	0.00	0.25	0.000	0.00





PB 15-21 17.08 0.00 0.25 0.000 0.00

CARGA VIVA ACCIDENTAL.**CARGAS EN
ELEMENTOS**

EJE	NIVEL	CRUJIA	L o # m o SIN	A m ²	W ton/m ²	P ton	WE ton
15	AZOT	F-G	2.00	36.91	0.07	1.292	2.584
		G-J	2.00	34.55	0.07	1.209	2.419
		J-K	2.00	34.55	0.07	1.209	2.419
		K-M	2.00	34.55	0.07	1.209	2.419
		M-N	2.00	40.69	0.07	1.424	2.848
	1ER	F-G	2.00	34.37	0.18	3.093	6.187
		G-J	2.00	32.17	0.18	2.895	5.791
		J-K	2.00	32.17	0.18	2.895	5.791
		K-M	2.00	32.17	0.18	2.895	5.791
		M-N	2.00	32.17	0.18	2.895	5.791
	P.B.	F-G	2.00	38.94	0.18	3.505	7.009
		G-J	2.00	33.45	0.18	3.011	6.021
		J-K	2.00	33.45	0.18	3.011	6.021
		K-M	2.00	33.45	0.18	3.011	6.021
		M-N	2.00	38.94	0.18	3.505	7.009
21	AZOT	F-G	2.00	36.91	0.07	1.292	2.584
		G-J	2.00	34.55	0.07	1.209	2.419
		J-K	2.00	34.55	0.07	1.209	2.419
		K-M	2.00	34.55	0.07	1.209	2.419
		M-N	2.00	40.69	0.07	1.424	2.848
	1ER	F-G	2.00	34.37	0.18	3.093	6.187
		G-J	2.00	32.17	0.18	2.895	5.791
		J-K	2.00	32.17	0.18	2.895	5.791
		K-M	2.00	32.17	0.18	2.895	5.791
		M-N	2.00	32.17	0.18	2.895	5.791
	P.B.	F-G	2.00	38.94	0.18	3.505	7.009
		G-J	2.00	33.45	0.18	3.011	6.021
		J-K	2.00	33.45	0.18	3.011	6.021
		K-M	2.00	33.45	0.18	3.011	6.021
		M-N	2.00	38.94	0.18	3.505	7.009





		M-N	2.00	38.94	0.18	3.505	7.009
F	AZOT	15-IZQ	2.75	0.00	0.07	0.000	0.000
		IZQ-DER	11.58	0.00	0.07	0.000	0.000
		DER-21	2.75	0.00	0.07	0.000	0.000
	1ER	15-IZQ	2.75	0.00	0.18	0.000	0.000
		IZQ-DER	11.58	0.00	0.02	0.000	0.000
		DER-21	2.75	0.00	0.18	0.000	0.000
	P.B.	15-IZQ	4.24	0.00	0.02	0.000	0.000
		IZQ-DER	12.84	0.00	0.02	0.000	0.000
		DER-21	4.24	0.00	0.02	0.000	0.000
N	AZOT	15-IZQ	2.75	0.00	0.07	0.000	0.000
		IZQ-DER	11.58	0.00	0.07	0.000	0.000
		DER-21	2.75	0.00	0.07	0.000	0.000
	1ER	15-IZQ	2.75	0.00	0.18	0.000	0.000
		IZQ-DER	11.58	0.00	0.02	0.000	0.000
		DER-21	2.75	0.00	0.18	0.000	0.000
	P.B.	15-IZQ	4.24	0.00	0.02	0.000	0.000
		IZQ-DER	12.84	0.00	0.02	0.000	0.000
		DER-21	4.24	0.00	0.02	0.000	0.000
G.J.K.M	AZOT	15-21	17.08	0.00	0.07	0.000	0.000
	1ER	15-21	17.08	0.00	0.18	0.000	0.000
	PB	15-21	17.08	0.00	0.18	0.000	0.000

CARGAS POR PLANTA.

AZOTEA

CARGA MUERTA

				W =	422.64 ton	
				XC =	8.79 m	
				ZC =	9.86 m	
EJE	CRUJIA	WE	X	Z	X*WE	Z*WE
		ton	m	m	ton-m	ton-m
15	F-G	40.85	0.00	1.83	0.00	74.76
	G-J	37.22	0.00	5.49	0.00	204.34
	J-K	36.27	0.00	9.15	0.00	331.87
	K-M	36.27	0.00	12.81	0.00	464.62
	M-N	45.08	0.00	16.47	0.00	742.14





21	F-G	40.85	17.08	1.83	697.72	74.76
	G-J	37.22	17.08	5.49	635.72	204.34
	J-K	36.27	17.08	9.15	619.49	331.87
	K-M	36.27	17.08	12.81	619.49	464.62
	M-N	45.06	17.08	16.47	769.62	742.14
F	15-IZQ	1.18	1.38	18.30	1.63	21.59
	IZQ-DER	0.00	8.54	18.30	0.00	0.00
	DER-21	1.18	15.71	18.30	18.54	21.59
N	15-IZQ	1.18	1.38	0.00	1.63	0.00
	IZQ-DER	0.00	8.54	0.00	0.00	0.00
	DER-21	1.18	15.71	0.00	18.54	0.00
G.M	15-21	0.00	8.54	9.15	0.00	0.00
15	F	7.11	0.00	18.30	0.00	130.11
	G	0.00	0.00	14.64	0.00	0.00
	J	0.00	0.00	10.98	0.00	0.00
	K	0.00	0.00	7.32	0.00	0.00
	M	0.00	0.00	3.66	0.00	0.00
	N	0.00	0.00	0.00	0.00	0.00
	21	F	19.50	17.08	18.30	333.06
G	0.00	17.08	14.64	0.00	0.00	
J	0.00	17.08	10.98	0.00	0.00	
K	0.00	17.08	7.32	0.00	0.00	
M	0.00	17.08	3.66	0.00	0.00	
N	0.00	17.08	0.00	0.00	0.00	

CARGA VIVA ACCIDENTAL

W = 25.37 ton
 XC = 8.54 m
 ZC = 9.3 m

EJE	CRUJIA	WE	X	Z	X*WE	Z*WE
		ton	m	m	ton-m	ton-m
15	F-G	2.58	0.00	1.83	0.00	4.72
	G-J	2.42	0.00	5.49	0.00	13.29
	J-K	2.42	0.00	9.15	0.00	22.14
	K-M	2.42	0.00	12.81	0.00	31.00
	M-N	2.85	0.00	16.47	0.00	46.94
21	F-G	2.58	17.08	1.83	44.07	4.72
	G-J	2.42	17.08	5.49	41.33	13.29
	J-K	2.42	17.08	9.15	41.33	22.14
	K-M	2.42	17.08	12.81	41.33	31.00
	M-N	2.85	17.08	16.47	48.68	46.94
F	15-IZQ	0.00	1.38	18.30	0.00	0.00





	IZQ-DER	0.00	8.54	18.30	0.00	0.00
	DER-21	0.00	15.71	18.30	0.00	0.00
N	15-IZQ	0.00	1.38	0.00	0.00	0.00
	IZQ-DER	0.00	8.54	0.00	0.00	0.00
	DER-21	0.00	15.71	0.00	0.00	0.00
G.M	15-21	0.00	8.54	9.15	0.00	0.00

NIVEL 1

CARGA MUERTA

W = 345.66 ton

XC = 8.43 m

ZC = 9.16 m

EJE	CRUJIA	WE ton	X m	Z m	X*WE ton-m	Z*WE ton-m	
15	F-G	31.85	0.00	1.83	0.00	58.29	
	G-J	24.51	0.00	5.49	0.00	134.58	
	J-K	31.33	0.00	9.15	0.00	286.67	
	K-M	31.33	0.00	12.81	0.00	401.34	
	M-N	30.93	0.00	16.47	0.00	509.42	
21	F-G	31.85	17.08	1.83	544.00	58.29	
	G-J	24.51	17.08	5.49	418.63	134.58	
	J-K	31.33	17.08	9.15	535.12	286.67	
	K-M	31.33	17.08	12.81	535.12	401.34	
	M-N	30.93	17.08	16.47	528.28	509.42	
F	15-IZQ	5.85	1.38	18.30	8.07	107.06	
	IZQ-DER	0.00	8.54	18.30	0.00	0.00	
	DER-21	5.85	15.71	18.30	91.90	107.06	
N	15-IZQ	5.85	1.38	0.00	8.07	0.00	
	IZQ-DER	0.00	8.54	0.00	0.00	0.00	
	DER-21	5.85	15.71	0.00	91.90	0.00	
G.M	15-21	0.00	8.54	9.15	0.00	0.00	
	15	F	2.24	0.00	18.30	0.00	40.99
		G	2.24	0.00	14.64	0.00	32.79
		J	2.24	0.00	10.98	0.00	24.60
		K	2.24	0.00	7.32	0.00	16.40
		M	2.24	0.00	3.66	0.00	8.20
		N	2.24	0.00	0.00	0.00	0.00
21		F	0.00	17.08	18.30	0.00	0.00
	G	0.00	17.08	14.64	0.00	0.00	
	J	2.24	17.08	10.98	38.26	24.60	
	K	2.24	17.08	7.32	38.26	16.40	





M	2.24	17.08	3.86	38.26	8.20
N	2.24	17.08	0.00	38.26	0.00

CARGA VIVA ACCIDENTAL

				W =	58.7 ton	
				XC =	8.54 m	
				ZC =	9.05 m	
EJE	CRUJIA	WE	X	Z	X*WE	Z*WE
		ton	m	m	ton-m	ton-m
15	F-G	6.19	0.00	1.83	0.00	11.33
	G-J	5.79	0.00	5.49	0.00	31.79
	J-K	5.79	0.00	9.15	0.00	52.98
	K-M	5.79	0.00	12.81	0.00	74.17
	M-N	5.79	0.00	16.47	0.00	95.36
21	F-G	6.19	17.08	1.83	105.73	11.33
	G-J	5.79	17.08	5.49	98.89	31.79
	J-K	5.79	17.08	9.15	98.89	52.98
	K-M	5.79	17.08	12.81	98.89	74.17
	M-N	5.79	17.08	16.47	98.89	95.36
F	15-IZQ	0.00	1.38	18.30	0.00	0.00
	IZQ-DER	0.00	8.54	18.30	0.00	0.00
	DER-21	0.00	15.71	18.30	0.00	0.00
N	15-IZQ	0.00	1.38	0.00	0.00	0.00
	IZQ-DER	0.00	8.54	0.00	0.00	0.00
	DER-21	0.00	15.71	0.00	0.00	0.00
G.M	15-21	0.00	8.54	9.15	0.00	0.00

PLANTA BAJA

CARGA MUERTA

				W =	471.61 ton	
				XC =	8.54 m	
				ZC =	8.89 m	
EJE	CRUJIA	WE	X	Z	X*WE	Z*WE
		ton	m	m	ton-m	ton-m
15	F-G	52.19	0.00	1.83	0.00	95.51
	G-J	33.21	0.00	5.49	0.00	182.33
	J-K	28.64	0.00	9.15	0.00	262.06
	K-M	33.21	0.00	12.81	0.00	425.42
	M-N	43.74	0.00	16.47	0.00	720.40
21	F-G	52.19	17.08	1.83	891.41	95.51
	G-J	33.21	17.08	5.49	567.26	182.33
	J-K	28.64	17.08	9.15	489.17	262.06





	K-M	33.21	17.08	12.81	567.23	425.42
	M-N	43.74	17.08	18.47	747.08	720.40
F	15-IZQ	11.60	1.38	18.30	16.01	212.28
	IZQ-DER	0.00	8.54	18.30	0.00	0.00
	DER-21	11.60	15.71	18.30	182.24	212.28
N	15-IZQ	11.60	1.38	0.00	16.01	0.00
	IZQ-DER	0.00	8.54	0.00	0.00	0.00
	DER-21	11.60	15.71	0.00	182.24	0.00
G.M	15-21	0.00	8.54	9.15	0.00	0.00
15	F	3.60	0.00	18.30	0.00	65.88
	G	3.60	0.00	14.84	0.00	52.70
	J	3.60	0.00	10.98	0.00	39.53
	K	3.60	0.00	7.32	0.00	26.35
	M	3.60	0.00	3.66	0.00	13.18
	N	3.60	0.00	0.00	0.00	0.00
21	F	3.60	17.08	18.30	61.49	65.88
	G	3.60	17.08	14.84	61.49	52.70
	J	3.60	17.08	10.98	61.49	39.53
	K	3.60	17.08	7.32	61.49	26.35
	M	3.60	17.08	3.66	61.49	13.18
	N	3.60	17.08	0.00	61.49	0.00

CARGA VIVA ACCIDENTAL

		W =		64.16 ton		
		XC =		8.54 m		
		ZC =		9.15 m		
EJE	CRUJIA	WE	X	Z	X*WE	Z*WE
		ton	m	m	ton-m	ton-m
15	F-G	7.01	0.00	1.83	0.00	12.83
	G-J	6.02	0.00	5.49	0.00	33.05
	J-K	6.02	0.00	9.15	0.00	55.08
	K-M	6.02	0.00	12.81	0.00	77.12
	M-N	7.01	0.00	16.47	0.00	115.45
21	F-G	7.01	17.08	1.83	119.73	12.83
	G-J	6.02	17.08	5.49	102.82	33.05
	J-K	6.02	17.08	9.15	102.82	55.08
	K-M	6.02	17.08	12.81	102.82	77.12
	M-N	7.01	17.08	16.47	119.73	115.45
F	15-IZQ	0.00	1.38	18.30	0.00	0.00
	IZQ-DER	0.00	8.54	18.30	0.00	0.00
	DER-21	0.00	15.71	18.30	0.00	0.00
N	15-IZQ	0.00	1.38	0.00	0.00	0.00





	IZQ-DER	0.00	8.54	0.00	0.00	0.00
	DER-21	0.00	15.71	0.00	0.00	0.00
G.M	15-21	0.00	8.54	9.15	0.00	0.00

CARGAS SISMICAS**CENTROS DE GRAVEDAD**

NIVEL	Wcm ton	Xcm m	Zcm m	Wcva ton	Xcva m	Zcva m
AZOTEA	422.64	8.79	9.86	25.37	8.54	9.3
NIVEL 1	345.66	8.43	9.16	58.7	8.54	9.05
P.B.	471.61	8.54	8.89	64.16	8.54	9.15

NIVEL	(W*X)cm ton-m	(W*Z)cm ton-m	(W*X)cva ton-m	(W*Z)cva ton-m	SUM(W*X) m	SUM(W*Z) m
AZOTEA	3715.01	4167.23	218.66	235.84	3931.67	4403.17
NIVEL 1	2913.91	3168.25	501.30	531.24	3415.21	3897.48
P.B.	4027.55	4182.61	547.93	587.06	4575.48	4779.68

NIVEL	SUM(W) ton	Xc m	Zc m
AZOTEA	448.01	8.78	9.83
NIVEL 1	404.36	8.45	9.14
P.B.	535.77	8.54	8.92

RESULTADOS.

LOS RESULTADOS DEL ANÁLISIS EN EL MARCO DEL EJE 15 Y EJE 21; SON LOS SIGUIENTES:

CARGA MUERTA**DESPLAZAMIENTOS DE NUDOS**



NUDO	DESPL. X cm	DESPL. Y cm	GIRO cm
1	0.005	-0.038	0.000
2	0.003	-0.075	0.000
3	0.001	-0.070	0.000
4	-0.001	-0.072	0.000
5	-0.003	-0.080	0.000
6	-0.005	-0.040	0.001
7	-0.003	-0.027	0.000
8	-0.002	-0.052	0.000
9	0.000	-0.049	0.000
10	0.001	-0.051	0.000
11	0.003	-0.058	0.000
12	0.004	-0.028	0.000
13	0.000	0.000	0.000
14	0.000	0.000	0.000
15	0.000	0.000	0.000
16	0.000	0.000	0.000
17	0.000	0.000	0.000
18	0.000	0.000	0.000

REACCIONES DE APOYO

NUDO	REAC. X kg	REAC. Y kg	MOMENTO kg-cm
13	795.925	40541.539	131286.875
14	-121.568	74774.453	-17547.684
15	160.826	7031.375	26001.113
16	-3.259	73423.602	-1927.138
17	-121.770	79506.336	-22579.273
18	-710.253	42163.672	-118961.219

ACCIONES DE EXTREMOS DE LOS MIEMBROS

MIEMBRO	NUDO	AXIAL kg	CORTANTE kg	MOMENTO kg-cm
1	1	3841.251	18964.172	-817670.190
	2	-3841.251	21909.229	1338905.500
2	2	3167.606	18732.758	-1210050.750
	3	-3167.606	18480.643	1148034.250
3	3	3341.218	18241.584	-1161237.750





	4	-3341.218	18031.816	1107440.000
4	4	3385.995	17731.740	-1111744.120
	5	3385.995	18541.660	1244549.000
5	5	4071.383	23922.238	-1421688.880
	6	-4071.383	21171.164	898419.940
6	7	-3045.318	15737.371	-865890.690
	8	3045.318	18198.030	938265.250
7	8	-2493.255	12096.438	-775050.620
	9	2493.255	12414.963	822530.880
8	9	-2505.922	15404.205	-925319.810
	10	2505.922	15927.196	1006807.500
9	10	-2553.979	15892.846	-1019575.060
	11	2553.979	15438.556	922219.880
10	11	-3361.145	15783.892	-964862.190
	12	3361.145	15152.509	842168.690
11	7	18964.160	-3841.244	815113.940
	1	-18964.160	3841.244	817870.190
12	8	40642.000	673.630	-122409.320
	2	-40642.000	-673.630	-128854.695
13	9	38722.227	-173.590	51545.672
	3	-38722.227	173.590	13203.536
14	10	35763.602	-44.796	12404.797
	4	-35763.602	44.796	4303.956
15	11	42483.883	685.390	78512.516
	5	-42483.883	685.390	177137.797
16	12	21171.145	4071.390	-620208.620
	6	-21171.145	-4071.390	-898419.880
17	13	38941.539	-795.925	131266.875
	7	-38941.539	795.925	250776.922
18	14	71174.453	121.568	-17547.684
	8	-71174.453	-121.568	-40805.184
19	15	88781.375	-160.926	26001.113
	9	-88781.375	160.926	51243.215
20	16	69823.602	3.259	-1827.136
	10	-69823.602	-3.259	382.665
21	17	75906.336	121.770	-22579.273
	11	-75906.336	-121.770	-35870.230
22	18	38563.672	710.253	-118961.219
	12	-38563.672	-710.253	-221959.984





CARGA VIVA MAXIMA

DESPLAZAMIENTOS DE NUDOS

NUDO	DESPL. X	DESPL. Y	GIRO
	cm	cm	cm
1	0.001	-0.005	0.000
2	0.001	-0.011	0.000
3	0.000	-0.010	0.000
4	0.000	-0.010	0.000
5	0.000	-0.011	0.000
6	-0.001	-0.005	0.000
7	0.000	-0.004	0.000
8	0.000	-0.009	0.000
9	0.000	-0.008	0.000
10	0.000	-0.008	0.000
11	0.000	-0.009	0.000
12	0.001	-0.004	0.000
13	0.000	0.000	0.000
14	0.000	0.000	0.000
15	0.000	0.000	0.000
16	0.000	0.000	0.000
17	0.000	0.000	0.000
18	0.000	0.000	0.000

REACCIONES DE APOYO

NUDO	REAC. X	REAC. Y	MOMENTO
	kg	kg	kg-cm
13	251.110	5869.999	40576.062
14	-24.815	12166.496	-3790.113
15	2.791	11497.675	429.551
16	-3.364	11497.859	-745.685
17	5.184	12076.850	424.438
18	-230.906	5811.312	-37582.328

ACCIONES DE EXTREMOS DE LOS MIEMBROS

MIEMBRO	NUDO	AXIAL	CORTANTE	MOMENTO
		kg	kg	kg-cm





1	1	580.835	1804.763	-96071.062
	2	-580.835	1895.237	110777.750
2	2	524.166	1702.781	-103573.219
	3	-524.166	1757.219	111805.383
3	3	518.881	1729.313	-109790.742
	4	-518.881	1730.687	108312.164
4	4	524.144	1725.487	-109808.492
	5	-524.144	1734.533	109737.633
5	5	582.141	2087.520	-120681.273
	6	-582.141	1992.480	101249.047
6	7	-329.728	4065.239	-200538.344
	8	329.728	4534.762	282181.120
7	8	-297.868	4033.714	-260105.266
	9	297.868	4006.286	251065.875
8	9	-287.797	4004.860	-251274.250
	10	287.797	4035.140	252795.375
9	10	-298.420	4006.564	-253137.797
	11	298.420	4033.436	254035.375
10	11	-351.236	4221.167	-286789.190
	12	351.236	3818.833	189142.000
11	7	1804.766	-580.839	120581.719
	1	-1804.766	580.839	96071.102
12	8	3598.016	56.674	-13934.960
	2	-3598.016	-56.674	-7204.534
13	9	3486.535	7.282	-701.558
	3	-3486.535	-7.282	-2014.645
14	10	3456.158	-7.260	1211.495
	4	-3456.158	7.260	1496.314
15	11	3822.056	-57.999	10690.098
	5	-3822.056	57.999	10943.853
16	12	1992.479	582.141	-115889.609
	6	-1992.479	-582.141	-101248.984
17	13	5869.999	-251.110	40576.062
	7	-5869.999	251.110	78956.742
18	14	12166.496	24.815	-3790.113
	8	-12166.496	-24.815	-8120.869
19	15	11497.875	-2.791	429.551
	9	-11497.875	2.791	909.928
20	16	11497.859	3.364	-745.685
	10	-11497.859	-3.364	-869.073
21	17	12076.650	-5.184	424.438





	11	-12076.650	5.184	2063.737
22	18	5811.312	230.906	-37582.328
	12	-5812.312	-230.906	-73252.352

CARGA VIVA ACCIDENTAL

DESPLAZAMIENTOS DE NUDOS

NUDO	DESPL. X cm	DESPL. Y cm	GIRO cm
1	0.001	-0.004	0.000
2	0.000	-0.008	0.000
3	0.000	-0.007	0.000
4	0.000	-0.007	0.000
5	0.000	-0.008	0.000
6	0.000	-0.004	0.000
7	0.000	-0.003	0.000
8	0.000	-0.006	0.000
9	0.000	-0.006	0.000
10	0.000	-0.006	0.000
11	0.000	-0.006	0.000
12	0.000	-0.003	0.000
13	0.000	0.000	0.000
14	0.000	0.000	0.000
15	0.000	0.000	0.000
16	0.000	0.000	0.000
17	0.000	0.000	0.000
18	0.000	0.000	0.000

REACCIONES DE APOYO

NUDO	REAC. X kg	REAC. Y kg	MOMENTO kg-cm
13	180.875	4180.635	29223.397
14	-17.582	8679.223	-2682.884
15	2.084	8218.830	324.483
16	-2.475	8218.912	-539.290
17	4.246	8819.431	396.586
18	-167.148	4142.965	-27189.326





ACCIONES DE EXTREMOS DE LOS MIEMBROS

MIEMBRO	NUDO	AXIAL kg	CORTANTE kg	MOMENTO kg-cm
1	1	412.425	1261.185	-67684.453
	2	-412.425	1318.815	76940.875
2	2	373.551	1190.020	-72163.062
	3	-373.551	1229.980	78265.836
3	3	368.319	1209.445	-76808.852
	4	-368.319	1210.555	75801.938
4	4	373.534	1208.158	-78906.109
	5	-373.534	1211.842	76370.125
5	5	413.436	1450.231	-83719.266
	6	-413.436	1389.769	71234.562
6	7	-231.549	2919.451	-143746.469
	8	231.549	3260.549	203077.391
7	8	-210.257	2909.837	-187597.750
	9	210.257	2890.163	181097.406
8	9	-202.946	2889.244	-161261.312
	10	202.946	2910.756	162317.906
9	10	-210.829	2889.442	-182507.625
	11	210.829	2910.558	183471.797
10	11	-246.289	3046.803	-192648.297
	12	246.289	2753.197	136018.375
11	7	1261.186	-412.425	86150.102
	1	-1261.186	412.425	67684.453
12	8	2508.834	38.877	-9723.246
	2	-2508.834	-38.877	-4777.798
13	9	2439.425	5.225	-491.963
	3	-2439.425	-5.225	-1456.986
14	10	2418.716	-5.208	838.398
	4	-2418.716	5.208	1104.146
15	11	2662.074	-39.904	7535.198
	5	-2662.074	39.904	7349.141
16	12	1389.768	413.435	-82976.875
	6	-1389.768	-413.435	-71234.523
17	13	4180.635	-180.875	29223.397
	7	-4180.635	180.875	57596.406
18	14	8679.223	17.582	-2662.884
	8	-8679.223	-17.582	-5756.372





19	15	8218.830	-2.084	324.483
	9	-8218.830	2.084	675.863
20	16	8218.912	2.475	-539.290
	10	-8218.912	-2.475	-648.696
21	17	8619.431	-4.246	396.586
	11	-8619.431	4.246	1641.298
22	18	4142.965	167.148	-27189.326
	12	-4142.965	-167.148	-53041.477

SISMO

DESPLAZAMIENTOS DE NUDOS

NUDO	DESPL. X	DESPL. Y	GIRO
	cm	cm	cm
1	3.369	0.037	-0.001
2	3.321	-0.006	-0.001
3	3.284	0.000	-0.001
4	3.258	0.000	-0.001
5	3.242	0.005	-0.001
6	3.237	-0.036	-0.001
7	2.211	0.030	-0.003
8	2.190	-0.005	-0.002
9	2.172	0.000	-0.002
10	2.158	0.000	-0.002
11	2.148	0.005	-0.002
12	2.141	-0.029	-0.003
13	0.000	0.000	0.000
14	0.000	0.000	0.000
15	0.000	0.000	0.000
16	0.000	0.000	0.000
17	0.000	0.000	0.000
18	0.000	0.000	0.000

REACCIONES DE APOYO

NUDO	REAC. X	REAC. Y	MOMENTO
	kg	kg	kg-cm
13	-21891.758	-41203.020	-6120324.0
14	-25871.365	7233.427	-6732176.0





15	-25275.262	18.392	-6615945.5
16	-25127.996	608.894	-6575914.5
17	-25412.876	6222.924	-6609436.0
18	-21323.981	39565.254	-5947442.0

ACCIONES DE EXTREMOS DE LOS MIEMBROS

MIEMBRO	NUDO	AXIAL kg	CORTANTE kg	MOMENTO kg-cm
1	1	85417.023	-12518.081	2499812.000
	2	-85417.023	12518.081	2081805.620
2	2	65635.742	-10725.425	1964521.880
	3	-65635.742	10725.425	1960983.500
3	3	46984.801	-10421.941	1910996.880
	4	-46984.801	10421.941	1903433.500
4	4	28567.602	-10480.359	1922772.500
	5	-28567.602	10480.359	1913039.250
5	5	9534.477	-11847.756	1987647.500
	6	-9534.477	11874.456	2358513.500
6	7	37597.055	-28684.953	5699515.000
	8	-37597.055	28684.953	4799177.500
7	8	31506.471	-23244.180	4218492.500
	9	-31506.471	23244.180	4288877.500
8	9	24881.006	-23529.287	4312008.500
	10	-24881.006	23529.287	4299712.500
9	10	18170.232	-22861.973	4229382.000
	11	-18170.232	22861.973	4138100.200
10	11	11789.601	-27690.494	4648616.500
	12	-11789.601	27690.494	5486104.000
11	7	-12518.100	10218.781	-1311793.000
	1	12518.100	-10218.781	-2499812.500
12	8	1792.655	19779.947	-3331589.200
	2	-1792.655	-19779.947	-4046329.800
13	9	303.496	18650.637	-3084705.500
	3	-303.496	-18650.637	-3871982.000
14	10	-58.420	18417.627	-3043569.800
	4	58.420	-18417.627	-3826203.800
15	11	-1394.406	19031.506	-3198067.800
	5	1394.406	-19031.506	-3900684.000
16	12	11874.750	9534.996	-1198036.000
	6	-11874.750	-9534.996	-2358516.800





17	13	-41203.020	21891.758	-6120324.000
	7	41203.020	-21891.758	-4387720.000
18	14	7233.427	25871.365	-6732176.000
	8	-7233.427	-25871.365	-5686079.000
19	15	18.392	25275.262	-6615945.500
	9	-18.392	-25275.262	-5516180.000
20	16	608.894	25127.996	-6575914.500
	10	-608.894	-25127.996	-5485523.500
21	17	-6222.924	25412.676	-6609436.000
	11	6222.924	-25412.676	-5588647.000
22	18	39565.254	21323.981	-5947442.000
	12	-39565.254	-21323.981	-4288069.000

CALCULO DE DESPLAZAMIENTOS PARA ENCONTRAR LA RIGIDEZ

APLICANDO UNA CARGA DE 10000 KG SE TIENEN LOS SIGUIENTES DESPLAZAMIENTOS

NUDO	DESPL. X	DESPL. Y	GIRO
1	0.271	0.003	0.000
2	0.267	-0.001	0.000
3	0.263	0.000	0.000
4	0.260	0.000	0.000
5	0.259	0.000	0.000
6	0.258	-0.003	0.000
7	0.157	0.003	0.000
8	0.157	-0.001	0.000
9	0.157	0.000	0.000
10	0.157	0.000	0.000
11	0.157	0.000	0.000
12	0.156	-0.002	0.000
13	0.000	0.000	0.000
14	0.000	0.000	0.000
15	0.000	0.000	0.000





16	0.000	0.000	0.000
17	0.000	0.000	0.000
18	0.000	0.000	0.000

MIEMBRO	K (kg/cm)
11	38900.369
12	37453.18352
13	38022.81369
14	38481.53846
15	38610.03861
16	38759.68992
17	63694.26752
18	63694.26752
19	63694.26752
20	63694.26752
21	63694.26752
22	64102.5641

ANALISIS SISMICO

NIVEL	ENTREPISO	Wi (ton)	H _i (m)	Wi x Hi	F (ton)	V
AZOTEA		448.01	8.53	3821.5253	66%	191.27
	2					191.27
	1°	404.36	4.8	1940.928	34%	98.54
	1					289.81
	Σ	852.37		5762.4533		
		$V_o = (0.68 \cdot 852.37) / 2$				
		$V_o = 289.81$				

Xg	Yg	F _{xg}	F _{yg}	ΣF _{xg}	ΣF _{yg}	Xv	Yv
8.78	9.83	1679.35	1880.18	1679.35	1880.18	8.78	9.83
8.45	9.14	832.66	900.66	2512.01	2780.84	8.67	9.60





DISEÑO

SE REALIZO DE ACUERDO AL SIGUIENTE REGLAMENTO:

REGLAMENTO DEL ACI DE 1989.

UTILIZANDO EL PROGRAMA PARA DISEÑO ESTRUCTURAL SAFE - 2000.

MATERIALES:

PILOTES, SON DE CONCRETO REFORZADO DE $f'c=250 \text{ kg/cm}^2$
 COLUMNAS PREFABRICADAS, SON DE CONCRETO REFORZADO DE $f'c=350 \text{ kg/cm}^2$
 MUROS, SON DE CONCRETO REFORZADO DE $f'c=350 \text{ kg/cm}^2$
 TRABES, SON DE CONCRETO REFORZADO DE $f'c=350 \text{ kg/cm}^2$
 TRABES "T", SON DE CONCRETO PRETENSADO DE $f'c=350 \text{ kg/cm}^2$
 FIRME ESTRUCTURAL, SON DE CONCRETO PRETENSADO DE $f'c=250 \text{ kg/cm}^2$
 ACERO DE REFUERZO, $f_y=4200 \text{ kg/cm}^2$
 ACERO DE PRESFUERZO, $F_{pu}=19000 \text{ kg/cm}^2$

DISEÑO DE COLUMNAS.

ESTOS SON LOS RESULTADOS DEL DISEÑO DE LAS COLUMNAS DEL EDIFICIO.

ENUMERADAS DE LA SIG. FORMA:

11	12	13	14	15	16
17	18	19	20	21	22

Cargas: Ton, Ton-M.



JOSE FERNANDO CANO SUAREZ



Columna 11:

Archivo.: COL 11	Pcm.: 18.96	My1 cm.: 0	Var #.: 10
Título.: COLUMNA 11	Pcv.: 1.8	My1 cv.: 0	Var Esq.: 1
B.: .5	PcaX.: -12.5	My1 ca.: 0	Var X.: 1
H.: .5	PcaY.: 0	My2 cm.: 0	Var Y.: 1
Rec.: 0.06	Mx1 cm.: -8.18	My2 cv.: 0	Var est #: 4
Lx.: 3.23	Mx1 cv.: -0.96	My2 ca.: -27.17	Sismo.: M
Ly.: 3.73	Mx1 ca.: 24.9	Fc.: 350	Contraventeo X: N
Lcx.: 3.73	Mx2 cm.: 6.15	Ec.: 261916	Contraventeo Y: N
Lcy.: 3.73	Mx2 cv.: 1.21	Fy.: 4200	Kx.: 0.5
	Mx2 ca.: -13.12	Fy Est.: 4200	Ky.: 1.0

Combinaciones:

Cm	Cv	CaX	CaY	f min	f max
1	1	.3	1	.03	.99
1	1	1	.3	.37	1
1	1	0	0	.22	.99

9 Est # 4 @ 10, a cada extremo.

6 Est # 4 @ 21 al centro.

Columna 12:

Archivo.: COL 12	Pcm.: 40.64	My1 cm.: 0	Var #.: 10
Título.: COLUMNA 12	Pcv.: 3.59	My1 cv.: 0	Var Esq.: 1
B.: .5	PcaX.: 1.79	My1 ca.: 0	Var X.: 2
H.: .5	PcaY.: 0	My2 cm.: 0	Var Y.: 2
Rec.: 0.06	Mx1 cm.: 1.29	My2 cv.: 0	Var est #: 4
Lx.: 3.23	Mx1 cv.: .07	My2 ca.: -81.91	Sismo.: M
Ly.: 3.73	Mx1 ca.: 40.46	Fc.: 350	Contraventeo X: N
Lcx.: 3.73	Mx2 cm.: -1.22	Ec.: 261916	Contraventeo Y: N
Lcy.: 3.73	Mx2 cv.: -1.14	Fy.: 4200	Kx.: 0.5
	Mx2 ca.: -33.32	Fy Est.: 4200	Ky.: 1.0

Combinaciones:

Cm	Cv	CaX	CaY	f min	f max
1	1	.3	1	.33	.95
1	1	1	.3	.97	.97
1	1	0	0	.1	.88

9 Est # 4 @ 10, a cada extremo.

6 Est # 4 @ 21 al centro.

Columna 13:

Archivo.: COL 13	Pcm.: 36.98	My1 cm.: 0	Var #.: 10
Título.: COLUMNA 13	Pcv.: 3.51	My1 cv.: 0	Var Esq.: 1





B.....: .5	PcaX.....: -0.04	My1 ca.....: 0	Var X.....: 2
H.....: .5	PcaY.....: 0	My2 cm.....: 0	Var Y.....: 2
Rec.....: 0.06	Mx1 cm.....: -0.03	My2 cv.....: 0	Var est #: 4
Lx.....: 3.23	Mx1 cv.....: 0.03	My2 ca.....: -69.23	Sismo.....: M
Ly.....: 3.73	Mx1 ca.....: 36.79	Fc.....: 350	Contraventeo X: N
Lcx.....: 3.73	Mx2 cm.....: 0.46	Ec.....: 261916	Contraventeo Y: N
Lcy.....: 3.73	Mx2 cv.....: -0.02	Fy.....: 4200	Kx.....: 0.5
	Mx2 ca.....: -32.09	Fy Est.....: 4200	Ky.....: 1.0

Combinaciones:

Cm	Cv	CaX	CaY	f min	f max
1	1	.3	1	.27	.97
1	1	1	.3	.86	.99
1	1	0	0	.09	.81

9 Est # 4 @ 10, a cada extremo.

6 Est # 4 @ 21 al centro.

Columna 14:

Archivo...: COL 14	Pcm.....: 35.8	My1 cm.....: 0	Var #.....: 10
Título...: COLUMNA 14	Pcv.....: 3.46	My1 cv.....: 0	Var Esq...: 1
	PcaX.....: -0.06	My1 ca.....: 0	Var X.....: 2
B.....: .5	PcaY.....: 0	My2 cm.....: 0	Var Y.....: 2
H.....: .5	Mx1 cm.....: -0.04	My2 cv.....: 0	Var est #: 4
Rec.....: 0.06	Mx1 cv.....: -0.14	My2 ca.....: -69.23	Sismo.....: M
Lx.....: 3.23	Mx1 ca.....: 38.26	Fc.....: 350	Contraventeo X: N
Ly.....: 3.73	Mx2 cm.....: 0.12	Ec.....: 261916	Contraventeo Y: N
Lcx.....: 3.73	Mx2 cv.....: 0.12	Fy.....: 4200	Kx.....: 0.5
Lcy.....: 3.73	Mx2 ca.....: -30.43	Fy Est.....: 4200	Ky.....: 1.0

Combinaciones:

Cm	Cv	CaX	CaY	f min	f max
1	1	.3	1	.28	1
1	1	1	.3	.89	.99
1	1	0	0	.09	.78

9 Est # 4 @ 10, a cada extremo.

6 Est # 4 @ 21 al centro.

Columna 15:

Archivo...: COL 15	Pcm.....: 42.5	My1 cm.....: 0	Var #.....: 10
Título...: COLUMNA 15	Pcv.....: 3.82	My1 cv.....: 0	Var Esq...: 1
	PcaX.....: -1.4	My1 ca.....: 0	Var X.....: 2
B.....: .5	PcaY.....: 0	My2 cm.....: 0	Var Y.....: 2
H.....: .5	Mx1 cm.....: -1.77	My2 cv.....: 0	Var est #: 4
Rec.....: 0.06	Mx1 cv.....: -0.11	My2 ca.....: -81.91	Sismo.....: M





Lx.....: 3.23 Mx1 ca...: 39 Fc.....: 350 Contraventeo X: N
 Ly.....: 3.73 Mx2 cm...: 0.79 Ec.....: 261916 Contraventeo Y: N
 Lcx.....: 3.73 Mx2 cv...: 0.11 Fy.....: 4200 Kx.....: 0.5
 Ley.....: 3.73 Mx2 ca...: -31.20 Fy Est...: 4200 Ky.....: 1.0

Combinaciones:

Cm	Cv	CaX	CaY	f min	f max
1	1	.3	1	.25	.96
1	1	1	.3	.88	1
1	1	0	0	.11	.92

9 Est # 4 @ 10, a cada extremo.

6 Est # 4 @ 21 al centro.

Columna 16:

Archivo...: COL 16 Pcm.....: 21.17 My1 cm...: 0 Var #.....: 10
 Título...: COLUMNA 16 Pcv.....: 1.9 My1 cv...: 0 Var Esq...: 1
 PcaX.....: 11.9 My1 ca...: 0 Var X.....: 1
 B.....: .5 PcaY.....: 0 My2 cm...: 0 Var Y.....: 1
 H.....: .5 Mx1 cm...: 8.98 My2 cv...: 0 Var est #: 4
 Rec.....: 0.06 Mx1 cv...: 1.01 My2 ca...: -27.17 Sismo...: M
 Lx.....: 3.23 Mx1 ca...: 23.6 Fc.....: 350 Contraventeo X: N
 Ly.....: 3.73 Mx2 cm...: -6.2 Ec.....: 261916 Contraventeo Y: N
 Lcx.....: 3.73 Mx2 cv...: -1.16 Fy.....: 4200 Kx.....: 0.5
 Ley.....: 3.73 Mx2 ca...: -11.9 Fy Est...: 4200 Ky.....: 1.0

Combinaciones:

Cm	Cv	CaX	CaY	f min	f max
1	1	.3	1	.4	.99
1	1	1	.3	.6	1
1	1	0	0	.22	.99

9 Est # 4 @ 10, a cada extremo.

6 Est # 4 @ 21 al centro.

Columna 17:

Archivo...: COL 17 Pcm.....: 36.94 My1 cm...: 0 Var #.....: 10
 Título...: COLUMNA 17 Pcv.....: 5.9 My1 cv...: 0 Var Esq...: 1
 PcaX.....: -41.2 My1 ca...: 27.17 Var X.....: 2
 B.....: .6 PcaY.....: 0 My2 cm...: 0 Var Y.....: 2
 H.....: .6 Mx1 cm...: -2.51 My2 cv...: 0 Var est #: 4
 Rec.....: 0.06 Mx1 cv...: -0.8 My2 ca...: -80.18 Sismo...: M
 Lx.....: 4.30 Mx1 ca...: 43.9 Fc.....: 350 Contraventeo X: N
 Ly.....: 4.80 Mx2 cm...: 1.31 Ec.....: 261916 Contraventeo Y: N
 Lcx.....: 4.80 Mx2 cv...: 0.41 Fy.....: 4200 Kx.....: 0.5
 Ley.....: 4.80 Mx2 ca...: -61.2 Fy Est...: 4200 Ky.....: 1.0





Combinaciones:

Cm	Cv	CaX	CaY	f min	f max
1	1	.3	1	.4	1
1	1	1	.3	.8	.97
1	1	0	0	.07	.95

8 Est # 4 @ 13 a cada extremo.

7 Est # 4 @ 26 al centro.

Columna 18:

Archivo...: COL 18	Pcm.....: 67.9	My1 cm...: 0	Var #.....: 10
Título...: COLUMNA 18	Pcv.....: 11.64	My1 cv...: 0	Var Esq...: 1
B.....: .6	PcaX.....: 15.91	My1 ca...: 81.91	Var X.....: 4
H.....: .6	PcaY.....: 0	My2 cm...: 0	Var Y.....: 4
Rec.....: 0.06	Mx1 cm...: -0.01	My2 cv...: 0	Var est #: 4
Lx.....: 4.30	Mx1 cv...: -0.02	My2 ca...: -241.61	Sismo.....: M
Ly.....: 4.80	Mx1 ca...: 35.27	F'c.....: 350	Contraventeo X: N
Lcx.....: 4.80	Mx2 cm...: 0.05	Ec.....: 261916	Contraventeo Y: N
Lcy.....: 4.80	Mx2 cv...: 0.01	Fy.....: 4200	Kx.....: 0.5
	Mx2 ca...: -42.41	Fy Est...: 4200	Ky.....: 1.0

Combinaciones:

Cm	Cv	CaX	CaY	f min	f max
1	1	.3	1	.96	.98
1	1	1	.3	.61	1
1	1	0	0	.12	.94

8 Est # 4 @ 13 + 1 rama en Y, a cada extremo.

7 Est # 4 @ 26 al centro.

Columna 19:

Archivo...: COL 19	Pcm.....: 67.17	My1 cm...: 0	Var #.....: 10
Título...: COLUMNA 19	Pcv.....: 11.55	My1 cv...: 0	Var Esq...: 1
B.....: .6	PcaX.....: -.77	My1 ca...: 69.23	Var X.....: 4
H.....: .6	PcaY.....: 0	My2 cm...: 0	Var Y.....: 4
Rec.....: 0.06	Mx1 cm...: -0.52	My2 cv...: 0	Var est #: 4
Lx.....: 4.30	Mx1 cv...: 0.002	My2 ca...: -204.22	Sismo.....: M
Ly.....: 4.80	Mx1 ca...: 32.45	F'c.....: 350	Contraventeo X: N
Lcx.....: 4.80	Mx2 cm...: 0.27	Ec.....: 261916	Contraventeo Y: N
Lcy.....: 4.80	Mx2 cv...: -0.002	Fy.....: 4200	Kx.....: 0.5
	Mx2 ca...: -40.79	Fy Est...: 4200	Ky.....: 1.0

Combinaciones:

Cm	Cv	CaX	CaY	f min	f max
1	1	.3	1	.8	.99
1	1	1	.3	.49	1





1 1 0 0 .12 .93

8 Est # 4 @ 13 + 1 rama en Y, a cada extremo.

7 Est # 4 @ 26 al centro.

Columna 20:

Archivo.: COL 20	Pcm.....: 69.82	My1 cm.....: 0	Var #.....: 10
Título.: COLUMNA 20	Pcv.....: 11.5	My1 cv.....: 0	Var Esq...: 1
	PcaX.....: 0.6	My1 ca.....: 69.23	Var X.....: 3
B.....: .6	PcaY.....: 0	My2 cm.....: 0	Var Y.....: 3
H.....: .6	Mx1 cm.....: -.003	My2 cv.....: 0	Var est #: 4
Rec.....: 0.06	Mx1 cv.....: 0.008	My2 ca.....: -204.22	Sismo.....: M
Lx.....: 4.30	Mx1 ca.....: 54.86	Fc.....: 350	Contraventeo X: N
Ly.....: 4.80	Mx2 cm.....: -0.02	Ec.....: 261916	Contraventeo Y: N
Lcx.....: 4.80	Mx2 cv.....: -0.007	Fy.....: 4200	Kx.....: 0.5
Lcy.....: 4.80	Mx2 ca.....: -65.8	Fy Est.....: 4200	Ky.....: 1.0

Combinaciones:

Cm	Cv	CaX	CaY	f min	f max
1	1	.3	1	.99	.99
1	1	1	.3	.81	.98
1	1	0	0	.13	.83

8 Est # 4 @ 13 + 1 rama en Y, a cada extremo.

7 Est # 4 @ 26 al centro.

Columna 21:

Archivo.: COL 21	Pcm.....: 75.91	My1 cm.....: 0	Var #.....: 10
Título.: COLUMNA 21	Pcv.....: 12.1	My1 cv.....: 0	Var Esq...: 1
	PcaX.....: -6.2	My1 ca.....: 81.91	Var X.....: 5
B.....: .6	PcaY.....: 0	My2 cm.....: 0	Var Y.....: 5
H.....: .6	Mx1 cm.....: 0.36	My2 cv.....: 0	Var est #: 4
Rec.....: 0.06	Mx1 cv.....: -0.02	My2 ca.....: -241.61	Sismo.....: M
Lx.....: 4.30	Mx1 ca.....: 55.9	Fc.....: 350	Contraventeo X: N
Ly.....: 4.80	Mx2 cm.....: -0.23	Ec.....: 261916	Contraventeo Y: N
Lcx.....: 4.80	Mx2 cv.....: 0.004	Fy.....: 4200	Kx.....: 0.5
Lcy.....: 4.80	Mx2 ca.....: -66.1	Fy Est.....: 4200	Ky.....: 1.0

Combinaciones:

Cm	Cv	CaX	CaY	f min	f max
1	1	.3	1	.91	.97
1	1	1	.3	.72	1
1	1	0	0	.13	.89

7 Est # 4 @ 13 + 1 rama en Y, a cada extremo.

9 Est # 4 @ 26 al centro.





Columna 22:

Archivo.: COL 22	Pcm.....: 38.56	My1 cm.: 0	Var #.....: 10
Título.: COLUMNA 22	Pcv.....: 5.8	My1 cv.: 0	Var Esq.: 1
	PcaX.....: 39.6	My1 ca.: 27.17	Var X.....: 7
B.....: .6	PcaY.....: 0	My2 cm.: 0	Var Y.....: 7
H.....: .6	Mx1 cm.: 2.22	My2 cv.: 0	Var est #: 4
Rec.....: 0.06	Mx1 cv.: 73.3	My2 ca.: -80.18	Sismo.....: M
Lx.....: 4.30	Mx1 ca.: 42.9	F'c.....: 350	Contraventeo X: N
Ly.....: 4.80	Mx2 cm.: -1.19	Ec.....: 261916	Contraventeo Y: N
Lcx.....: 4.80	Mx2 cv.: -37.6	Fy.....: 4200	Kx.....: 0.5
Lcy.....: 4.80	Mx2 ca.: -59.5	Fy Est.: 4200	Ky.....: 1.0

Combinaciones:

Cm	Cv	CaX	CaY	f min	f max
1	1	.3	1	.78	1
1	1	1	.3	.94	.99
1	1	0	0	.37	1

8 Est # 4 @ 13 a cada extremo.

7 Est # 4 @ 26 al centro.

TOMANDO LOS RESULTADOS OBTENIDOS EN EL DISEÑO LAS COLUMNAS SUPERIORES SE CONSTRUIRÁN SOBRE LA BASE DEL DISEÑO DE LA COLUMNA DOCE, Y LAS INFERIORES BASÁNDOSE EN LA COLUMNA VEINTIDÓS.

DISEÑO DE TRABES.

LAS TRABES ESTÁN NUMERADAS COMO SIGUE:

1	2	3	4	5
6	7	8	9	10





Num. de trabe:	1		
f'c (kg/cm ²):	350	Carga uniforme 1 (kg):	1490
fy (kg/cm ²):	4200	Carga uniforme 2 (kg):	1490
Long. (m):	3.7	Carga uniforme 3 (kg):	1490
b (cm):	50	Distancia 1 (m):	0.8
h (cm):	50	Distancia 2 (m):	2.1
Long. Apoyo Izq.(cm):	50	Distancia 3 (m):	0.8
Long. Apoyo Der.(cm):	50		
Carga viva (kg):	100		
Carga muerta (kg):	834		
recubrimiento (cm):	2		
# de la Var. Principal:	10		
# de la Var. Estribo:	4		
Ramas del estribo:	4		
Mom. Izq. C. Vertical (kg-m):	-9137.4		
Mom. Der. C. Vertical (kg-m):	-14496.8		
Mom. Izq. C. Accid. (kg-m):	24998.1		
Mom. Der. C. Accid. (kg-m):	-20818.1		
Mod. Elast. Conc. (kg-cm ²):	261916		
Carga concentrada 1 (kg):	19560		
Carga concentrada 2 (kg):	19560		
Reac. Izq. C. Vertical (kg):	21027		
Reac. Izq. C. Accidental (kg):	12382		
Reac. Der. C. Vertical (kg):	23606		
Reac. Der. C. Accidental (kg):	-12382		
Mom. (+) Max (envol) (kg-m):	20043	Loc. Mom.(+) (del apoyo Izq)	1
		(m):	
Mom. (+) Max (c.vert.) (kg-m):	7428	Loc. Mom.(+) (del apoyo Izq)	1
		(m):	

ACERO EN LECHO SUPERIOR

Cant.		Long. Inic (m)	Long. Final (m)
2	Var. N° # 10	0	3.7
0.7	Var. N° # 10	0	1.6





0.7	Var. N° # 10	2.1	3.7
ACERO EN LECHO INFERIOR			
2	Var. N° # 10	0	3.7
0.3	Var. N° # 10	0	1.9

DISTRIBUCION DE ESTRIBOS**CUATRO RAMAS**

	Long. Inic (m)	Long. Final (m)
# 4 @ 11 cm	0	1.4
# 4 @ 23 cm	1.4	2.1
# 4 @ 11 cm	2.1	3.7

Deflexión Inst. por C. Viva(cm):	0.01
Deflexión Inst. por C. Muerta(cm):	0.08
Deflexión a largo plazo (cm):	0.13
Deflexión total (cm):	0.22

Longitud de desarrollo en las juntas

varillas rectas:

tensión:

lecho superior (cm):	139
lecho inferior (cm):	107
compresión (cm):	53

ganchos estándar:

tensión (cm):	54
compresión (cm):	53
Long. del doblé en ganchos (cm):	54

Num. de trabe: 2

$f'c$ (kg/cm ²):	350	Carga uniforme 1 (kg):	1490
f_y (kg/cm ²):	4200	Carga uniforme 2 (kg):	1490
Long. (m):	3.7	Carga uniforme 3 (kg):	1490
b (cm):	50	Distancia 1 (m):	0.8
h (cm):	50	Distancia 2 (m):	2.1
Long. Apoyo Izq.(cm):	50	Distancia 3 (m):	0.8
Long. Apoyo Der.(cm):	50		





Carga viva (kg):	100		
Carga muerta (kg):	834		
recubrimiento (cm):	2		
# de la Var. Principal:	10		
# de la Var. Estribo:	4		
Ramas del estribo:	4		
Mom. Izq. C. Vertical (kg-m):	-13136.2		
Mom. Der. C. Vertical (kg-m):	-12598.4		
Mom. Izq. C. Accid. (kg-m):	19645.2		
Mom. Der. C. Accid. (kg-m):	-19609.8		
Mod. Elast. Conc. (kg-cm ²):	261916		
Carga concentrada 1 (kg):	17610		
Carga concentrada 2 (kg):	17610		
Reac. Izq. C. Vertical (kg):	20655		
Reac. Izq. C. Accidental (kg):	10609		
Reac. Der. C. Vertical (kg):	20078		
Reac. Der. C. Accidental (kg):	-10609		
Mom. (+) Max (envol) (kg-m):	14111	Loc. Mom.(+) (del apoyo lzq)	2.9
		(m):	
Mom. (+) Max (c.vert.) (kg-m):	4237	Loc. Mom.(+) (del apoyo lzq)	2
		(m):	

ACERO EN LECHO SUPERIOR

Cant.		Long. Inic (m)	Long. Final (m)
2	Var. N° # 10	0	3.7
0.5	Var. N° # 10	0	1.6
0.4	Var. N° # 10	2.1	3.7

ACERO EN LECHO INFERIOR

2	Var. N° # 10	0	3.7
---	--------------	---	-----

DISTRIBUCION DE ESTRIBOS

	CUATRO RAMAS	Long. Inic (m)	Long. Final (m)
# 4 @ 11 cm		0	1.4
# 4 @ 23 cm		1.4	2.1
# 4 @ 11 cm		2.1	3.7





Deflexión Inst. por C. Viva(cm):	0
Deflexión Inst. por C. Muerta(cm):	0.05
Deflexión a largo plazo (cm):	0.08
Deflexión total (cm):	0.13

Longitud de desarrollo en las juntas

varillas rectas:

tensión:

lecho superior (cm): 139

lecho inferior (cm): 107

compresión (cm): 53

ganchos estándar:

tensión (cm): 54

compresión (cm): 53

Long. del dobléz en ganchos (cm): 54

Num. de trabe: 3

$f'c$ (kg/cm ²):	350	Carga uniforme 1 (kg):	1490
fy (kg/cm ²):	4200	Carga uniforme 2 (kg):	1490
Long. (m):	3.7	Carga uniforme 3 (kg):	1490
b (cm):	50	Distancia 1 (m):	0.8
h (cm):	50	Distancia 2 (m):	2.1
Long. Apoyo Izq.(cm):	50	Distancia 3 (m):	0.8
Long. Apoyo Der.(cm):	50		
Carga viva (kg):	100		
Carga muerta (kg):	834		
recubrimiento (cm):	2		
# de la Var. Principal:	10		
# de la Var. Estribo:	4		
Ramas del estribo:	4		
Mom. Izq. C. Vertical (kg-m):	-12710.3		
Mom. Der. C. Vertical (kg-m):	-12157.5		
Mom. Izq. C. Accid. (kg-m):	19110		
Mom. Der. C. Accid. (kg-m):	-19034.3		
Mod. Elast. Conc. (kg-cm ²):	261916		
Carga concentrada 1 (kg):	17140		
Carga concentrada 2 (kg):	17140		





Reac. Izq. C. Vertical (kg):	20185		
Reac. Izq. C. Accidental (kg):	10309		
Reac. Der. C. Vertical (kg):	19608		
Reac. Der. C. Accidental (kg):	-10309		
Mom. (+) Max (envol) (kg-m):	13822	Loc. Mom.(+) (del apoyo Izq)	0.8
		(m):	
Mom. (+) Max (c.vert.) (kg-m):	4283	Loc. Mom.(+) (del apoyo Izq)	2
		(m):	

ACERO EN LECHO SUPERIOR

Cant.		Long. Inic (m)	Long. Final (m)
2	Var. N° # 10	0	3.7
0.4	Var. N° # 10	0	1.6
0.4	Var. N° # 10	2.1	3.7

ACERO EN LECHO INFERIOR

2	Var. N° # 10	0	3.7
---	--------------	---	-----

DISTRIBUCION DE ESTRIBOS

	CUATRO RAMAS Long. Inic (m)	Long. Final (m)
# 4 @ 11 cm	0	1.4
# 4 @ 23 cm	1.4	2.1
# 4 @ 11 cm	2.1	3.7

Deflexión Inst. por C. Viva(cm):	0
Deflexión Inst. por C. Muerta(cm):	0.05
Deflexión a largo plazo (cm):	0.08
Deflexión total (cm):	0.14

Longitud de desarrollo en las juntas varillas rectas: tensión:

lecho superior (cm):	139
lecho inferior (cm):	107
compresión (cm):	53





ganchos estándar:

tensión (cm):	54
compresión (cm):	53
Long. del dobléz en ganchos (cm):	54

Num. de trabe: 4

f 'c (kg/cm ²) :	350	Carga uniforme 1 (kg):	1490
f _y (kg/cm ²) :	4200	Carga uniforme 2 (kg):	1490
Long. (m):	3.7	Carga uniforme 3 (kg):	1490
b (cm):	50	Distancia 1 (m):	0.8
h (cm):	50	Distancia 2 (m):	2.1
Long. Apoyo Izq.(cm):	50	Distancia 3 (m):	0.8
Long. Apoyo Der.(cm):	50		
Carga viva (kg):	100		
Carga muerta (kg):	834		
recubrimiento (cm):	2		
# de la Var. Principal:	10		
# de la Var. Estribo:	4		
Ramas del estribo:	4		
Mom. Izq. C. Vertical (kg-m):	-12215.5		
Mom. Der. C. Vertical (kg-m):	-13542.9		
Mom. Izq. C. Accid. (kg-m):	19227.7		
Mom. Der. C. Accid. (kg-m):	-19130.4		
Mod. Elast. Conc. (kg-cm ²):	261916		
Carga concentrada 1 (kg):	17140		
Carga concentrada 2 (kg):	17140		
Reac. Izq. C. Vertical (kg):	19677		
Reac. Izq. C. Accidental (kg):	10367		
Reac. Der. C. Vertical (kg):	20116		
Reac. Der. C. Accidental (kg):	-10367		
Mom. (+) Max (envol) (kg-m):	13983	Loc. Mom.(+) (del apoyo Izq) (m):	0.8
Mom. (+) Max (c.vert.) (kg-m):	3827	Loc. Mom.(+) (del apoyo Izq) (m):	1.7

ACERO EN LECHO





SUPERIOR			
	Cant.		
		Long. Inic (m)	Long. Final (m)
	2	Var. N° # 10	0
	0.4	Var. N° # 10	3.7
	0.5	Var. N° # 10	0
			1.6
ACERO EN LECHO INFERIOR			2.1
			3.7
	2	Var. N° # 10	0
			3.7
DISTRIBUCION DE ESTRIBOS		CUATRO RAMAS	
		Long. Inic (m)	Long. Final (m)
	# 4 @ 11 cm	0	1.4
	# 4 @ 23 cm	1.4	2.1
	# 4 @ 11 cm	2.1	3.7
Deflexión Inst. por C. Viva(cm):		0	
Deflexión Inst. por C. Muerta(cm):		0.04	
Deflexión a largo plazo (cm):		0.07	
Deflexión total (cm):		0.12	
Longitud de desarrollo en las juntas			
varillas rectas:			
tensión:			
	lecho superior (cm):	139	
	lecho inferior (cm):	107	
	compresión (cm):	53	
ganchos estándar:			
	tensión (cm):	54	
	compresión (cm):	53	
Long. del dobléz en ganchos (cm):		54	
Num. de trabe:		5	
f 'c (kg/cm²) :	350	Carga uniforme 1 (kg):	1490
f_y (kg/cm²) :	4200	Carga uniforme 2 (kg):	1490
Long. (m):	3.7	Carga uniforme 3 (kg):	1490
b (cm):	50	Distancia 1 (m):	0.8





h (cm):	50	Distancia 2 (m):	2.1
Long. Apoyo Izq. (cm):	50	Distancia 3 (m):	0.8
Long. Apoyo Der. (cm):	50		
Carga viva (kg):	100		
Carga muerta (kg):	834		
recubrimiento (cm):	2		
# de la Var. Principal:	10		
# de la Var. Estribo:	4		
Ramas del estribo:	4		
Mom. Izq. C. Vertical (kg-m):	-15423.7		
Mom. Der. C. Vertical (kg-m):	-9996.7		
Mom. Izq. C. Accid. (kg-m):	19876.5		
Mom. Der. C. Accid. (kg-m):	-23585.1		
Mod. Elast. Conc. (kg-cm ²):	261916		
Carga concentrada 1 (kg):	21860		
Carga concentrada 2 (kg):	21860		
Reac. Izq. C. Vertical (kg):	26261		
Reac. Izq. C. Accidental (kg):	11746		
Reac. Der. C. Vertical (kg):	22972		
Reac. Der. C. Accidental (kg):	-11746		
Mom. (+) Max (envol) (kg-m):	22094	Loc. Mom.(+) (del apoyo Izq) (m):	2.9
Mom. (+) Max (c.vert.) (kg-m):	8764	Loc. Mom.(+) (del apoyo Izq) (m):	2.8

ACERO EN LECHO SUPERIOR

Cant.		Long. Inic (m)	Long. Final (m)
2	Var. N° # 10	0	3.7
0.5	Var. N° # 10	0	1.6
0.5	Var. N° # 10	2.1	3.7

ACERO EN LECHO INFERIOR

2	Var. N° # 10	0	3.7
0.3	Var. N° # 10	0	1.8
0.1	Var. N° # 10	2.8	3.7

DISTRIBUCION DE ESTRIBOS

CUATRO RAMAS





	Long. Inic (m)	Long. Final (m)	
# 4 @ 11 cm	0	1.4	
# 4 @ 23 cm	1.4	2.1	
# 4 @ 11 cm	2.1	3.7	
Deflexión Inst. por C. Viva(cm):	0.01		
Deflexión Inst. por C. Muerta(cm):	0.11		
Deflexión a largo plazo (cm):	0.18		
Deflexión total (cm):	0.3		
Longitud de desarrollo en las juntas varillas rectas:			
tensión:			
lecho superior (cm):	139		
lecho inferior (cm):	107		
compresión (cm):	53		
ganchos estándar:			
tensión (cm):	54		
compresión (cm):	53		
Long. del dobléz en ganchos (cm):	54		
Num. de trabe:	6		
f 'c (kg/cm ²) :	350	Carga uniforme 1 (kg):	2390
f _y (kg/cm ²) :	4200	Carga uniforme 2 (kg):	2390
Long. (m):	3.7	Carga uniforme 3 (kg):	2540
b (cm):	50	Carga uniforme 4 (kg):	2390
h (cm):	50	Carga uniforme 5 (kg):	2390
Long. Apoyo Izq.(cm):	50	Distancia 1 (m):	0.8
Long. Apoyo Der.(cm):	50	Distancia 2 (m):	0.8
Carga viva (kg):	250	Distancia 3 (m):	0.5
Carga muerta (kg):	614	Distancia 4 (m):	0.8
recubrimiento (cm):	2	Distancia 5 (m):	0.8
# de la Var. Principal:	9		
# de la Var. Estribo:	4		
Ramas del estribo:	4		
Mom. Izq. C. Vertical (kg-m):	-10664.3		
Mom. Der. C. Vertical (kg-m):	-12204.3		





Mom. Izq. C. Accid. (kg-m):	56995.1		
Mom. Der. C. Accid. (kg-m):	-47991.8		
Mod. Elast. Conc. (kg-cm ²):	261916		
Carga concentrada 1 (kg):	15860		
Carga concentrada 4 (kg):	15860		
Reac. Izq. C. Vertical (kg):	19902		
Reac. Izq. C. Accidental (kg):	20733		
Reac. Der. C. Vertical (kg):	28374		
Reac. Der. C. Accidental (kg):	-28374		
Mom. (+) Max (envol) (kg-m):	14356	Loc. Mom.(+) (del apoyo Izq)	1.7
		(m):	
Mom. (+) Max (c.vert.) (kg-m):	5599	Loc. Mom.(+) (del apoyo Izq)	1.7
		(m):	

ACERO EN LECHO SUPERIOR

Cant.		Long. Inic (m)	Long. Final (m)
2	Var. Nº # 9	0	3.7
4	Var. Nº # 9	0	2
2.1	Var. Nº # 9	0	1.4
3	Var. Nº # 9	2	3.7
1.7	Var. Nº # 9	2.3	3.7

ACERO EN LECHO INFERIOR

3	Var. Nº # 9	0	3.7
3	Var. Nº # 9	0	2.1
1.2	Var. Nº # 9	0	1.3
2	Var. Nº # 9	1.9	3.7
0.5	Var. Nº # 9	2.6	3.7

DISTRIBUCION DE ESTRIBOS

	CUATRO RAMAS Long. Inic (m)	Long. Final (m)
# 4 @ 11 cm	0	1.4
# 4 @ 23 cm	1.4	2.1
# 4 @ 11 cm	2.1	3.7

Deflexión Inst. por C. Viva(cm):	0.1
Deflexión Inst. por C.	0.04





Muerta(cm):
 Deflexión a largo plazo (cm): 0.08
 Deflexión total (cm): 0.13

Longitud de desarrollo en las
 juntas

varillas rectas:

tensión:

lecho superior (cm): 112

lecho inferior (cm): 86

compresión (cm): 48

ganchos estándar:

tensión (cm): 48

compresión (cm): 48

Long. del dobléz en ganchos
 (cm): 49

Num. de trabe: 7

f'c (kg/cm ²) :	350	Carga uniforme 1 (kg):	790
fy (kg/cm ²) :	4200	Carga uniforme 2 (kg):	790
Long. (m):	3.7	Carga uniforme 3 (kg):	790
b (cm):	50	Distancia 1 (m):	0.8
h (cm):	50	Distancia 2 (m):	2.1
Long. Apoyo Izq.(cm):	50	Distancia 3 (m):	0.8
Long. Apoyo Der.(cm):	50		
Carga viva (kg):	250		
Carga muerta (kg):	614		
recubrimiento (cm):	2		
# de la Var. Principal:	10		
# de la Var. Estribo:	4		
Ramas del estribo:	4		
Mom. Izq. C. Vertical (kg-m):	-10351.6		
Mom. Der. C. Vertical (kg-m):	-10736		
Mom. Izq. C. Accid. (kg-m):	42184.9		
Mom. Der. C. Accid. (kg-m):	-42888.8		
Mod. Elast. Conc. (kg-cm ²):	261916		
Carga concentrada 1 (kg):	14830		
Carga concentrada 2 (kg):	14830		
Reac. Izq. C. Vertical (kg):	19902		





Reac. Izq. C. Accidental (kg):	20733		
Reac. Der. C. Vertical (kg):	28374		
Reac. Der. C. Accidental (kg):	-28374		
Mom. (+) Max (envol) (kg-m):	14356	Loc. Mom.(+) (del apoyo lzq)	1.7
		(m):	
Mom. (+) Max (c.vert.) (kg-m):	5599	Loc. Mom.(+) (del apoyo lzq)	1.7
		(m):	

ACERO EN LECHO SUPERIOR

Cant.		Long. Inic (m)	Long. Final (m)
2	Var. Nº # 10	0	3.7
4	Var. Nº # 10	0	2
2.1	Var. Nº # 10	0	1.4
3	Var. Nº # 10	2	3.7
1.7	Var. Nº # 10	2.3	3.7

ACERO EN LECHO INFERIOR

3	Var. Nº # 10	0	3.7
3	Var. Nº # 10	0	2.1
1.2	Var. Nº # 10	0	1.3
2	Var. Nº # 10	1.9	3.7
0.5	Var. Nº # 10	2.6	3.7

DISTRIBUCION DE ESTRIBOS

CUATRO RAMAS

	Long. Inic (m)	Long. Final (m)
# 4 @ 11 cm	0	1.4
# 4 @ 23 cm	1.4	2.1
# 4 @ 11 cm	2.1	3.7

Deflexión Inst. por C. Viva(cm):	0.1
Deflexión Inst. por C. Muerta(cm):	0.04
Deflexión a largo plazo (cm):	0.08
Deflexión total (cm):	0.13

Longitud de desarrollo en las juntas varillas rectas:





tensión:			
lecho superior (cm):	112		
lecho inferior (cm):	86		
compresión (cm):	48		
ganchos estándar:			
tensión (cm):	48		
compresión (cm):	48		
Long. del dobléz en ganchos (cm):	49		
Num. de trabe:	8		
f 'c (kg/cm ²) :	350	Carga uniforme 1 (kg):	790
f _y (kg/cm ²) :	4200	Carga uniforme 2 (kg):	790
Long. (m):	3.7	Carga uniforme 3 (kg):	790
b (cm):	50	Distancia 1 (m):	0.8
h (cm):	50	Distancia 2 (m):	2.1
Long. Apoyo Izq. (cm):	50	Distancia 3 (m):	0.8
Long. Apoyo Der. (cm):	50		
Carga viva (kg):	250		
Carga muerta (kg):	614		
recubrimiento (cm):	2		
# de la Var. Principal:	9		
# de la Var. Estribo:	4		
Ramas del estribo:	4		
Mom. Izq. C. Vertical (kg-m):	-11765.9		
Mom. Der. C. Vertical (kg-m):	-12596		
Mom. Izq. C. Accid. (kg-m):	43120.1		
Mom. Der. C. Accid. (kg-m):	-42997.1		
Mod. Elast. Conc. (kg-cm ²):	261916		
Carga concentrada 1 (kg):	18240		
Carga concentrada 4 (kg):	18240		
Reac. Izq. C. Vertical (kg):	19626		
Reac. Izq. C. Accidental (kg):	23274		
Reac. Der. C. Vertical (kg):	19777		
Reac. Der. C. Accidental (kg):	-23274		
Mom. (+) Max (envol) (kg-m):	5448	Loc. Mom.(+) (del apoyo Izq) (m):	1.8
Mom. (+) Max (c.vert.) (kg-m):	4223	Loc. Mom.(+) (del apoyo Izq) (m):	1.8





ACERO EN LECHO SUPERIOR

Cant.		Long. Inic (m)	Long. Final (m)
2	Var. N° # 9	0	3.7
3	Var. N° # 9	0	1.9
1.1	Var. N° # 9	0	1.4
0.5	Var. N° # 9	0	3.7
3	Var. N° # 9	2.1	3.7
1.1	Var. N° # 9	2.3	3.7

ACERO EN LECHO INFERIOR

2	Var. N° # 9	0	3.7
2	Var. N° # 9	0	2.1
1	Var. N° # 9	0	1.5
2	Var. N° # 9	1.6	3.7
0.8	Var. N° # 9	2.3	3.7

DISTRIBUCION DE ESTRIBOS

CUATRO RAMAS

	Long. Inic (m)	Long. Final (m)
# 4 @ 11 cm	0	1.4
# 4 @ 23 cm	1.4	2.1
# 4 @ 11 cm	2.1	3.7

Deflexión Inst. por C. Viva(cm):	0.01
Deflexión Inst. por C. Muerta(cm):	0.03
Deflexión a largo plazo (cm):	0.06
Deflexión total (cm):	0.1

Longitud de desarrollo en las juntas

varillas rectas:

tensión:

lecho superior (cm):	112
lecho inferior (cm):	86
compresión (cm):	48
ganchos estándar:	
tensión (cm):	48





compresión (cm): 48
 Long. del dobléz en ganchos (cm): 49

Num. de trabe: 9

f'c (kg/cm²): 350
 fy (kg/cm²): 4200
 Long. (m): 3.7
 b (cm): 50
 h (cm): 50
 Long. Apoyo Izq. (cm): 50
 Long. Apoyo Der. (cm): 50
 Carga viva (kg): 250
 Carga muerta (kg): 614
 Recubrimiento (cm): 2
 # de la Var. Principal: 9
 # de la Var. Estribo: 4
 Ramas del estribo: 4
 Mom. Izq. C. Vertical (kg-m): -12727.1
 Mom. Der. C. Vertical (kg-m): -11762.6
 Mom. Izq. C. Accid. (kg-m): 42293.8
 Mom. Der. C. Accid. (kg-m): -41381
 Mod. Elast. Conc. (kg-cm²): 261916
 Carga concentrada 1 (kg): 18240
 Carga concentrada 2 (kg): 18240

Carga uniforme 1 (kg): 790
 Carga uniforme 2 (kg): 790
 Carga uniforme 3 (kg): 790
 Distancia 1 (m): 0.8
 Distancia 2 (m): 2.1
 Distancia 3 (m): 0.8

Reac. Izq. C. Vertical (kg): 20111
 Reac. Izq. C. Accidental (kg): 22614
 Reac. Der. C. Vertical (kg): 19262
 Reac. Der. C. Accidental (kg): -22614
 Mom. (+) Max (envol) (kg-m): 16244
 Mom. (+) Max (c.vert.) (kg-m): 4262

Loc. Mom.(+) (del apoyo Izq) (m): 2.4
 Loc. Mom.(+) (del apoyo Izq) (m): 2.4

ACERO EN LECHO SUPERIOR

Cant.

Long. Inic (m)

Long. Final





2	Var. N° # 9	0	(m)
3	Var. N° # 9	0	3.7
1.1	Var. N° # 9	0	1.9
0.5	Var. N° # 9	0	1.4
2	Var. N° # 9	1.9	3.7
1.8	Var. N° # 9	2.3	3.7
ACERO EN LECHO INFERIOR			
2	Var. N° # 9	0	3.7
2	Var. N° # 9	0	2.1
0.8	Var. N° # 9	0	1.5
2	Var. N° # 9	1.8	3.7
0.7	Var. N° # 9	2.3	3.7

DISTRIBUCION DE ESTRIBOS**CUATRO RAMAS**

	Long. Inic (m)	Long. Final (m)
# 4 @ 11 cm	0	1.4
# 4 @ 23 cm	1.4	2.1
# 4 @ 11 cm	2.1	3.7

Deflexión Inst. por C. Viva(cm):	0.01
Deflexión Inst. por C. Muerta(cm):	0.03
Deflexión a largo plazo (cm):	0.06
Deflexión total (cm):	0.1

Longitud de desarrollo en las juntas
varillas rectas:
tensión:

Lecho superior (cm):	112
lecho inferior (cm):	86
compresión (cm):	48
ganchos estándar:	
tensión (cm):	48
compresión (cm):	48
Long. del dobléz en ganchos (cm):	49





Num. de trabe:	10		
$f'c$ (kg/cm ²):	350	Carga uniforme 1 (kg):	2540
f_y (kg/cm ²):	4200	Carga uniforme 2 (kg):	2540
Long. (m):	3.7	Carga uniforme 3 (kg):	2540
b (cm):	50	Distancia 1 (m):	0.8
h (cm):	50	Distancia 2 (m):	2.1
Long. Apoyo Izq.(cm):	50	Distancia 3 (m):	0.8
Long. Apoyo Der.(cm):	50		
Carga viva (kg):	250		
Carga muerta (kg):	614		
Recubrimiento (cm):	2		
# de la Var. Principal:	9		
# de la Var. Estribo:	4		
Ramas del estribo:	4		
Mom. Izq. C. Vertical (kg-m):	-12316.5		
Mom. Der. C. Vertical (kg-m):	-10313.1		
Mom. Izq. C. Accid. (kg-m):	46486.2		
Mom. Der. C. Accid. (kg-m):	-54861		
Mod. Elast. Conc. (kg-cm ²):	261916		
Carga concentrada 1 (kg):	14830		
Carga concentrada 2 (kg):	14830		
Reac. Izq. C. Vertical (kg):	20191		
Reac. Izq. C. Accidental (kg):	27391		
Reac. Der. C. Vertical (kg):	18867		
Reac. Der. C. Accidental (kg):	-27391		
Mom. (+) Max (envol) (kg-m):	16389	Loc. Mom.(+) (del apoyo Izq)	2.1
		(m):	
Mom. (+) Max (c.vert.) (kg-m):	5353	Loc. Mom.(+) (del apoyo Izq)	2.1
		(m):	

ACERO EN LECHO SUPERIOR

Cant.		Long. Inic (m)	Long. Final (m)
2	Var. N° # 9	0	3.7
3	Var. N° # 9	0	2
1.4	Var. N° # 9	0	1.4
0.5	Var. N° # 9	0	3.7





3	Var. N° # 9	1.8	3.7
2.8	Var. N° # 9	2.3	3.7
ACERO EN LECHO INFERIOR			
3	Var. N° # 9	0	3.7
2	Var. N° # 9	0	1.7
0.3	Var. N° # 9	0	1
2	Var. N° # 9	1.6	3.7
1.9	Var. N° # 9	2.1	3.7

DISTRIBUCION DE ESTRIBOS**CUATRO RAMAS**

	Long. Inic (m)	Long. Final (m)
# 4 @ 11 cm	0	1.4
# 4 @ 23 cm	1.4	2.1
# 4 @ 11 cm	2.1	3.7

Deflexión Inst. por C. Viva(cm):	0.01
Deflexión Inst. por C. Muerta(cm):	0.04
Deflexión a largo plazo (cm):	0.08
Deflexión total (cm):	0.13

Longitud de desarrollo en las juntas
varillas rectas:
tensión:

Lecho superior (cm):	112
lecho inferior (cm):	86
compresión (cm):	48
ganchos estándar:	
tensión (cm):	48
compresión (cm):	48
Long. del doblé en ganchos (cm):	49





DISEÑO DE CONTRATRABES DE CIMENTACION.

LAS CONTRATRABES ESTÁN NUMERADAS COMO SIGUE:

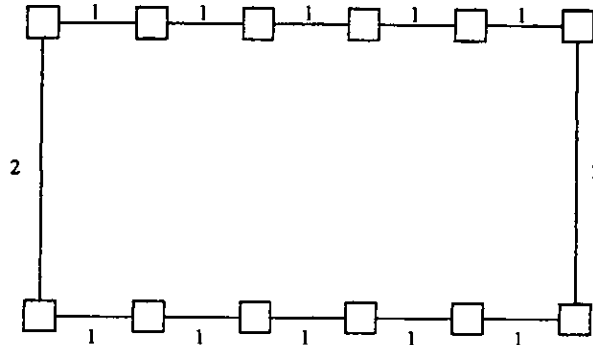

Num. de contratrabe:	1		
$f'c$ (kg/cm ²):	350	Carga uniforme 1 (kg):	0
f_y (kg/cm ²):	4200	Carga uniforme 2 (kg):	0
Long. (m):	3.7	Carga uniforme 3 (kg):	0
b (cm):	50	Distancia 1 (m):	1.6
h (cm):	120	Distancia 2 (m):	0.5
Long. Apoyo Izq.(cm):	50	Distancia 3 (m):	1.6
Long. Apoyo Der.(cm):	50		
Carga viva (kg):	250		
Carga muerta (kg):	614		
Recubrimiento (cm):	4		
# de la Var. Principal:	10		
# de la Var. Estribo:	4		
Ramas del estribo:	4		
Mom. Izq. C. Vertical (kg-m):	1720		
Mom. Der. C. Vertical (kg-m):	1720		
Mom. Izq. C. Accid. (kg-m):	-67300		
Mom. Der. C. Accid. (kg-m):	-67300		





Mod. Elast. Conc. (kg-cm ²):	261916		
Carga concentrada 1 (kg):	76300		
Carga concentrada 2 (kg):	76300		
Reac. Izq. C. Vertical (kg):	79057		
Reac. Izq. C. Accidental (kg):	0		
Reac. Der. C. Vertical (kg):	79057		
Reac. Der. C. Accidental (kg):	0		
Mom. (+) Max (envol) (kg-m):	193648	Loc. Mom.(+) (del apoyo Izq)	1.8
		(m):	
Mom. (+) Max (c.vert.) (kg-m):	126348	Loc. Mom.(+) (del apoyo Izq)	1.9
		(m):	

Acero lateral: 5 varillas del #4 @ cara

ACERO EN LECHO SUPERIOR

Cant.		Long. Inic (m)	Long. Final (m)
2.4	Var. N° # 10	0	3.7
0.1	Var. N° # 10	0	1.6
0.1	Var. N° # 10	2.1	3.7

ACERO EN LECHO INFERIOR

3	Var. N° # 10	0	3.7
3	Var. N° # 10	0	3.7
1.6	Var. N° # 10	0	3.7
0.8	Var. N° # 10	0	1.3
0.8	Var. N° # 10	0	3.7

DISTRIBUCION DE ESTRIBOS

	CUATRO RAMAS	Long. Inic (m)	Long. Final (m)
# 4 @ 25 cm		0	3.7

Deflexión Inst. por C. Viva(cm):	0.01
Deflexión Inst. por C. Muerta(cm):	0.07
Deflexión a largo plazo (cm):	0.15
Deflexión total (cm):	0.24

Longitud de desarrollo en las juntas





varillas rectas:

tensión:

lecho superior (cm): 139

lecho inferior (cm): 107

Compresión (cm): 53

Ganchos estándar:

tensión (cm): 54

compresión (cm): 53

Long. Del dobléz en ganchos (cm): 54

Num. De contratrabe: 2

f'c (kg/cm²): 350fy (kg/cm²): 4200

Long. (m): 17.1

b (cm): 50

h (cm): 120

Long. Apoyo Izq. (cm): 50

Long. Apoyo Der. (cm): 50

Carga viva (kg): 250

Carga muerta (kg): 614

Recubrimiento (cm): 4

de la Var. Principal: 10

de la Var. Estribo: 4

Ramas del estribo: 4

Mom. Izq. C. Vertical (kg-m): 0

Mom. Der. C. Vertical (kg-m): 0

Mom. Izq. C. Accid. (kg-m): 0

Mom. Der. C. Accid. (kg-m): 0

Mod. Elast. Conc. (kg-cm²): 261916

Carga concentrada 1 (kg): 38130

Carga concentrada 2 (kg): 38130

Reac. Izq. C. Vertical (kg): 38130

Reac. Izq. C. Accidental (kg): 0

Reac. Der. C. Vertical (kg): 38130

Reac. Der. C. Accidental (kg): 0

Mom. (+) Max (envol) (kg-m): 61009

Mom. (+) Max (c.vert.) (kg-m): 61009

Carga uniforme 1 (kg): 0

Carga uniforme 2 (kg): 0

Carga uniforme 3 (kg): 0

Distancia 1 (m): 1.6

Distancia 2 (m): 13.9

Distancia 3 (m): 1.6

Loc. Mom.(+) (del apoyo Izq) (m): 9.2

Loc. Mom.(+) (del apoyo Izq) 2.8





(m):

Acero lateral: 5 varillas del #4 @ cara

ACERO EN LECHO SUPERIOR

Cant.	Var. Nº # 10	Long. Inic (m)	Long. Final (m)
2		0	17.1

ACERO EN LECHO INFERIOR

2.8	Var. Nº # 10	0	17.1
-----	--------------	---	------

DISTRIBUCION DE ESTRIBOS**CUATRO RAMAS**

	Long. Inic (m)	Long. Final (m)
# 4 @ 25 cm	0	3.4
# 4 @ 57 cm	3.4	13.6
# 4 @ 25 cm	13.6	17.1

Deflexión Inst. por C. Viva(cm):	0.32
Deflexión Inst. por C. Muerta(cm):	1.56
Deflexión a largo plazo (cm):	3.22
Deflexión total (cm):	5.10

Longitud de desarrollo en las juntas

varillas rectas:

tensión:

lecho superior (cm):	139
lecho inferior (cm):	107
Compresión (cm):	53
Ganchos estándar:	
tensión (cm):	54
compresión (cm):	53
Long. Del dobléz en ganchos (cm):	54





DISEÑO DE MUROS DE CONCRETO.

LOS MUROS SE ENCUENTRAN LOCALIZADOS Y ESTÁN NUMERADOS COMO SIGUE:

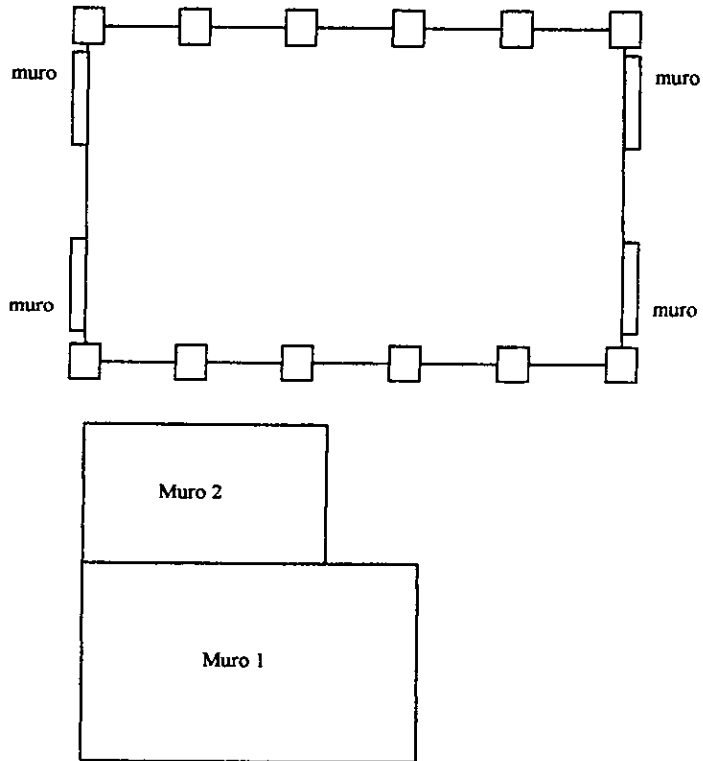

MURO 1

P (ton) = 26.53
M (ton-m) = 0





$$f'c \text{ (kg/cm}^2\text{)} = 350$$

$$fy \text{ (kg/cm}^2\text{)} = 4200$$

$$\text{Rec (cm)} = 3$$

$$Pu \text{ (ton)} = 37.14$$

$$Mu \text{ (ton-m)} = 0$$

$$e \text{ (m)} = 0.00$$

Se usara una sección de =	d cm	h cm	b cm
	17	20	424

$$d/h = 0.85$$

$$K = 0.26$$

$$R = 0.00$$

De tablas del manual de diseño de obras civiles de CFE se obtiene:

$$q = 0.1$$

Por lo tanto

$$p = q f'c / fy$$

$$p = 0.008$$

$$As = pbh$$

$$As(\text{cm}^2) = 70.67$$

se proponen varillas del # 5

Vs	Diam cm	Area cm ²	As cm ²
36	1.59	1.99	71.64

Se usaran refuerzo horizontal del # 5

# Vs	Diam cm	Area cm ²
5	1.59	1.99

$$\text{Sep} = (850 \times \emptyset) / \sqrt{fy} = 20.85$$





$48\phi =$		76.32
$b/2 =$		212.00
RIGE EL MENOR (cm) =		20.85
L =	424	Se colocara un doble emparrillado de 20 x 20 cm, con varilla del #5 en ambos sentidos
H =	480	
$V_{cr} = 0.85F_r v_f^* c h b$		
V_{cr} (ton) =	1.18	
$V_u =$	11.15	
ph =	0.008	
pv =	0.006	
Sh, Sv (cm) =	20	
Avh $cm^2 =$	3.10	2 Var#5 = 3.98 >> Avh
Avv $cm^2 =$	2.44	2 Var#5 = 3.98 >> Avv

MURO 2

P (ton) = 20.68
M (ton-m) = 0
f'c (kg/cm²) = 350
fy (kg/cm²) = 4200

Rec (cm) = 3

Pu (ton) = 28.95
Mu (ton-m) = 0

e (m) = 0.00





Se usara una sección de = d cm h cm b cm
 17 20 275

$$d/h = 0.85$$

$$K = 0.20$$

$$R = 0.0$$

De tablas del manual de diseño de obras civiles de CFE
se obtiene:

$$q = 0.1$$

Por lo tanto

$$p = q f'c / fy$$

$$p = 0.008$$

$$As = pbh$$

$$As(\text{cm}^2) = 45.83$$

se proponen varillas del # 5

Vs	Diam cm	Area cm ²	As cm ²
24	1.59	1.99	47.76

Se usaran refuerzo horizontal del # 5

# Vs	Diam cm	Area cm ²
5	1.59	1.99





$$\begin{aligned} \text{Sep} &= (850 \times \emptyset) / \sqrt{f_y} = 20.85 \\ 48\emptyset &= 76.32 \\ b/2 &= 137.50 \end{aligned}$$

$$\text{RIGE EL MENOR (cm)} = 20.85$$

$$L = 275 \quad \text{Se colocara un doble emparillado de } 20 \times 20 \text{ cm, con varilla del \#5 en ambos sentidos}$$

$$\begin{aligned} H &= 373 \\ V_{cr} &= 0.85 F_r \sqrt{f_c} h b \\ V_{cr} \text{ (ton)} &= 0.95 \end{aligned}$$

$$\begin{aligned} V_u &= 11.15 \\ p_h &= 0.008 \\ p_v &= 0.006 \end{aligned}$$

$$Sh, Sv \text{ (cm)} = 20$$

$$\begin{aligned} A_{vh} \text{ cm}^2 &= 3.17 & 2 \text{ Var}\#5 &= 3.98 \gg A_{vh} \\ A_{vv} \text{ cm}^2 &= 2.24 & 2 \text{ Var}\#5 &= 3.98 \gg A_{vv} \end{aligned}$$

DISEÑO DE PLACAS

$$\begin{aligned} f_y &= 2530 \text{ kg/cm}^2 \\ \text{Fuerza de tensión.} \\ F_t = 0.45 f_y &= 1138.5 \text{ kg/cm}^2 \end{aligned}$$

$$\begin{aligned} \text{Usando barrenos de } 1 \frac{1}{8}'' \text{ en placas de } \frac{1}{4}'' \\ \text{Area de placa} &= 7.3 * 0.635 = 4.64 \text{ cm}^2 \\ \text{Tensión resistente} &= 5278 \text{ kg} \end{aligned}$$

$$\begin{aligned} \text{Fuerza de aplastamiento} \\ F_a = 0.9 f_y &= 2277 \text{ kg/cm}^2 \end{aligned}$$

$$\begin{aligned} \text{Area} &= 2.54 * 0.635 = 1.61 \text{ cm}^2 \\ \text{Tensión resistente} &= 3673 \text{ kg} \end{aligned}$$

Usando tornillos estándar A-307 de 1" se tiene una resistencia de 2839 kg al aplastamiento,





Según manual ahmsa.

$$Vw = 1.4(11.15) = 15.61$$

$$15.61/2.8 = 5.6$$

Se usaran 6 tornillos como mínimo @ 45 cm

$$Vw = 1.4(12.96) = 18.14$$

$$18.14/2.8 = 6.5$$

Se usaran 7 tornillos como mínimo @ 60 cm

Sep. Min. al borde 32 mm según IMCA Tabla 1.16.5.1

Sep. Max. al borde 150 mm según IMCA Tabla 1.16.6

Sep. Entre agujeros. Min. 7.62 cm según IMCA Tabla 1.16.4.1





CONCLUSIONES

DE LA REALIZACIÓN DEL PRESENTE TRABAJO SE DESPRENDEN LAS SIGUIENTES

EN LA MEMORIA ENTREGADA POR EL DESPACHO QUE SE ENCARGO DEL PRIMER DISEÑO ESTRUCTURAL DE ESTOS EDIFICIOS SE HACE MENCIÓN DE QUE EL EDIFICIO TRABAJA BASÁNDOSE EN MARCOS EN SUS DOS DIRECCIONES, LO CUAL EN LA REALIDAD ESTO NO SUCEDE; PUES SOLAMENTE EXISTE EL MARCO EN UNA SOLA DIRECCIÓN.

LO ANTERIOR SE DEBE AL SISTEMA CONSTRUCTIVO UTILIZADO, YA QUE AL UTILIZAR COLUMNAS PREFABRICADAS COLOCADAS PARA SER PORTADORAS DE VIGAS T, EN SUS EXTREMOS; Y LAS MISMAS SOLO FUERON SIMPLEMENTE APOYADAS FUERA DE LOS EJES DE LAS COLUMNAS, LO QUE DA COMO RESULTADO QUE EN ESE





SENTIDO NO EXISTA UN MARCO, POR LO QUE EN ESE SENTIDO NO SE TOMO EN CUENTA.

CON LO ANTERIOR SE TIENE QUE EL SISMO EN UN SENTIDO SERÁ TOMADO POR EL EJE 15 Y 21, PERO EN EL OTRO SENTIDO LO TOMARAN LAS COLUMNAS QUE FORMAN LOS MARCOS ANTES MENCIONADOS Y NO LOS MUROS DE CONCRETO QUE SE CONTEMPLARAN SOLO EN EL HECHO ARQUITECTÓNICO Y NO EN EL ESTRUCTURAL .

AHORA COMO EL SISMO SERÁ TOMADO POR LAS COLUMNAS EN AMBAS DIRECCIONES, SE TIENE UN AUMENTO DE LAS SECCIONES DE LAS COLUMNAS LO QUE HACE QUE ESTAS CAMBIEN DE 50 X 50 CM A UNA SECCIÓN DE 60 X 60 CM ARMADAS CON VARILLAS DEL #10 Y ESTRIBOS DEL #4 EN LA PLANTA BAJA; Y EN EL 1ER PISO SE MANTIENE LA SECCIÓN DE 50 X 50 CM, CON UN ARMADO DE VARILLAS DEL #10 Y ESTRIBOS DEL #4.

ESTO DEBE SER
SALIR DE LA BIBLIOTECA



JOSE FERNANDO CANO SUAREZ



DEBIDO A LA SITUACIÓN ANTES DESCRITA, LAS TRABES DE LOS ENTREPISOS TAMBIÉN TOMARAN EL SISMO; AL REALIZAR LA REVISIÓN DE ESTAS SE TUVO COMO RESULTADO QUE LAS TRABES NO CAMBIAN DE DIMENSIÓN, POR LO QUE SERÁN DE 50 X 50 CM ARMADO CON VARILLAS DEL #10 Y ESTRIBOS DEL #4.

DEBIDO A QUE LOS MUROS DE CONCRETO YA NO TIENEN UNA FUNCIÓN ESTRUCTURAL SE CONSTRUIRÁN CON UNA FINALIDAD ARQUITECTÓNICA, CON EXCEPCIÓN DE LOS MUROS QUE DAN SOPORTE A LA ESTRUCTURA METÁLICA COLOCADA SOBRE EL VESTÍBULO PRINCIPAL. Y SE SUJETARAN A LA ESTRUCTURA POR MEDIO DE PLACAS Y ÁNGULOS CON AYUDA DE TORNILLOS.

COMO COMENTARIO FINAL TENEMOS QUE LA ESTRUCTURA QUE SE DISEÑO ORIGINALMENTE ES MUY SIMILAR A LA QUE SE OBTUVO EN ESTE PROYECTO POR LO QUE LOS RESULTADOS SE





ACEPTAN COMO BUENOS, REALIZANDO LAS PEQUEÑAS MODIFICACIONES A LA ESTRUCTURA. POSIBLEMENTE LAS DIMENSIONES DE LOS ELEMENTOS PAREZCAN MUY GRANDES, PERO SE DEBE TOMAR EN CUENTA QUE EL EDIFICIO PERTENECE A UNA CATEGORÍA DE TIPO "A", LO CUAL LO HACE DE GRAN IMPORTANCIA, POR LOS DAÑOS QUE PODRÍA CAUSAR SI ESTE PRESENTARA ALGÚN PROBLEMA PARA LA INSTITUCIÓN DE LA QUE ES PROPIEDAD, EN SUS BIENES Y SUS PERSONAS.



JOSE FERNANDO CANO SUAREZ



ANEXOS



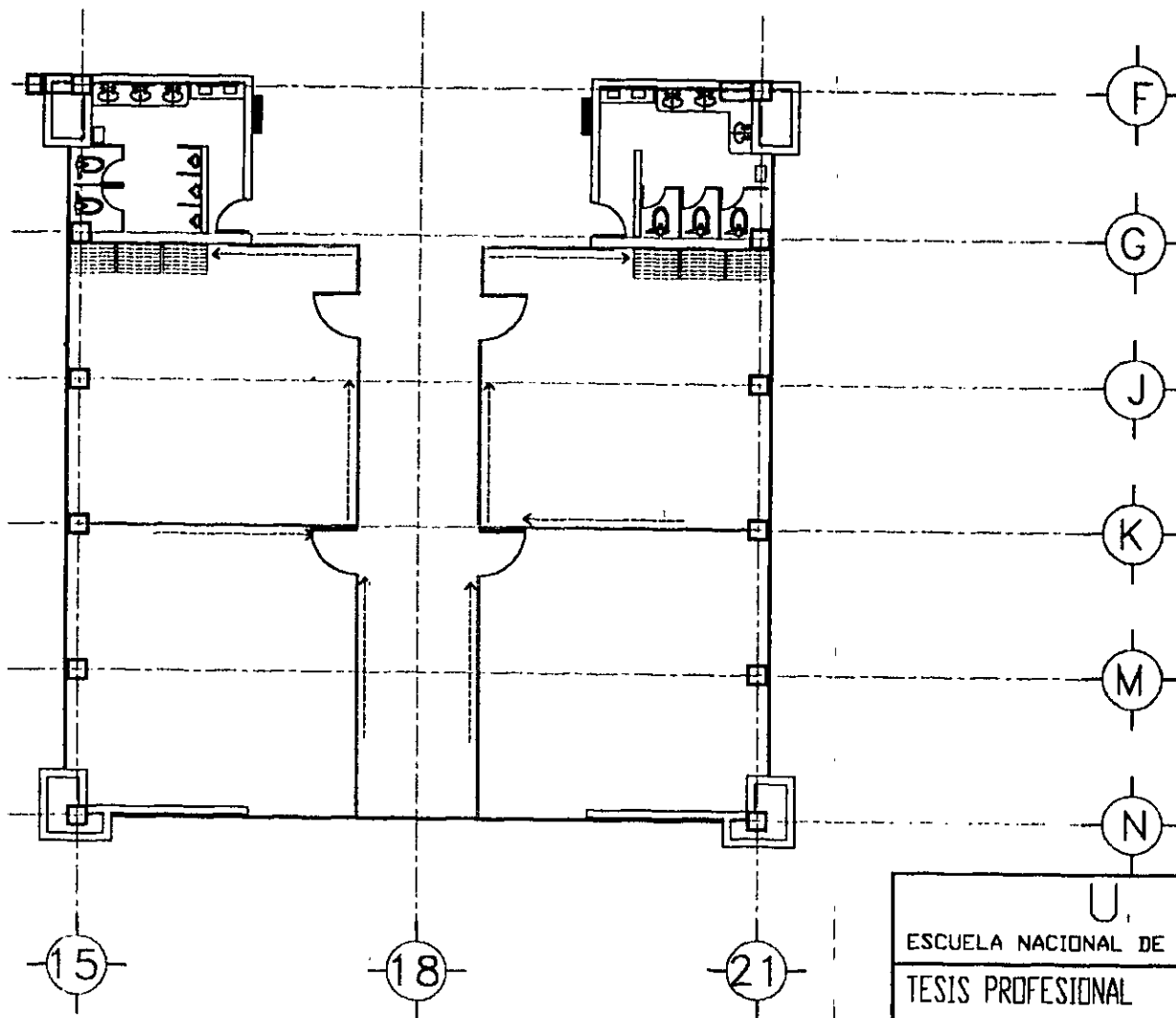

PLANTA BAJA EDIFICIO "B"

U. N. A. M. ESCUELA NACIONAL DE ESTUDIOS PROFESIONALES ARAGÓN	
TESIS PROFESIONAL JOSÉ FERNANDO CANO SUÁREZ	
PROYECTO UBICACIÓN	REVISIÓN DEL DISEÑO ESTRUCTURAL DEL EDIFICIO DE REPRESENTACIÓN DEL INSTITUTO MEXICANO DEL PETRÓLEO (CUERPO B) CIUDAD DEL CARMEN, CAMPECHE.
ESC: S/E PLANO	PLANTA BAJA EDIFICIO "B"

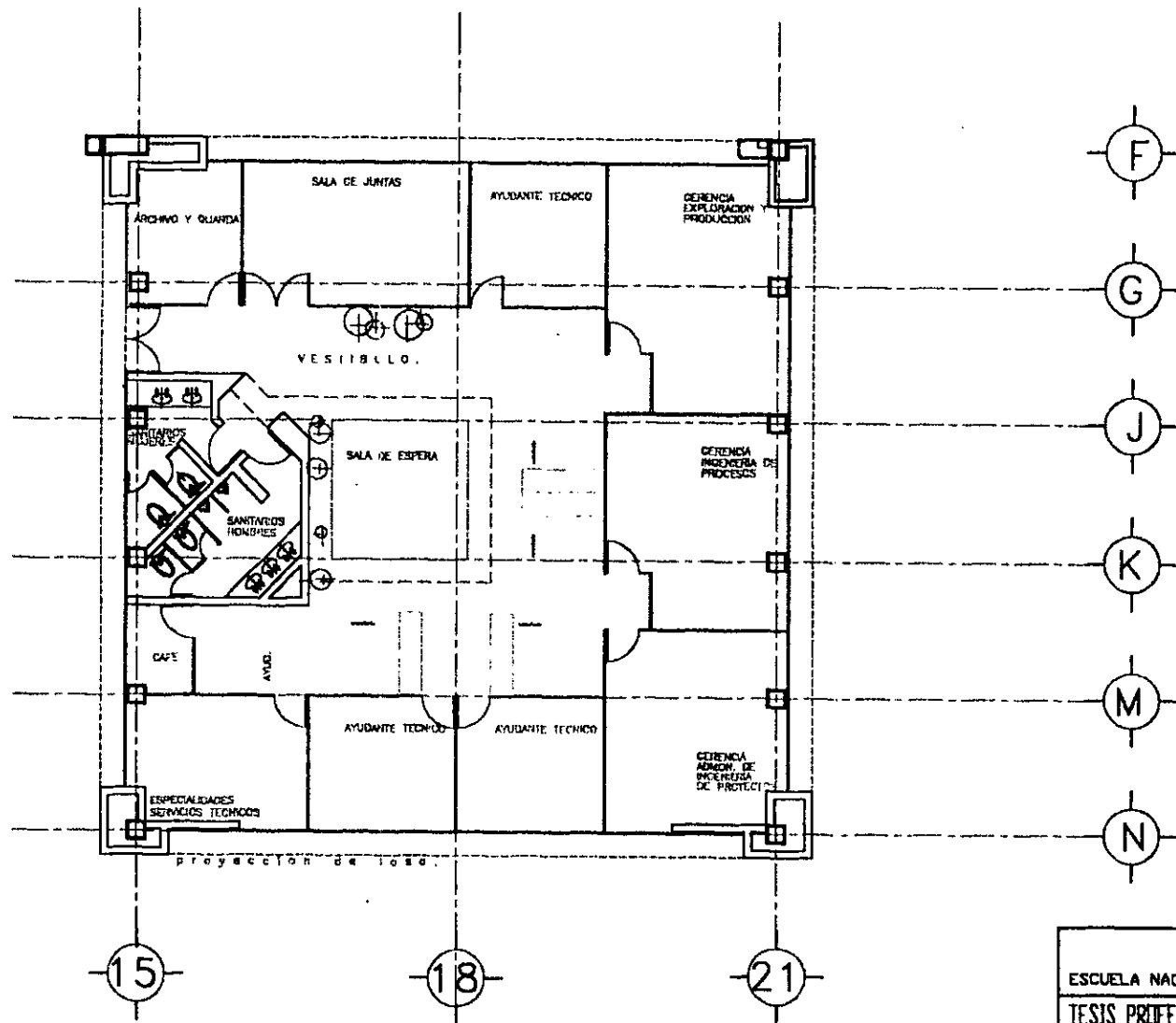

PLANTA 1ER NIVEL EDIFICIO "B"

U. N. A. M.	
ESCUELA NACIONAL DE ESTUDIOS PROFESIONALES ARAGON	
TESIS PROFESIONAL JOSÉ FERNANDO CANO SUAREZ	
PROYECTO	REVISION DEL DISEÑO ESTRUCTURAL DEL EDIFICIO DE REPRESENTACION
UBICACION	DEL INSTITUTO MEXICANO DEL PETROLEO (CUERPO B) CIUDAD DEL CARMEN, CAMPECHE.
ESD S/E	PLANO PLANTA 1ER NIVEL EDIFICIO "B"

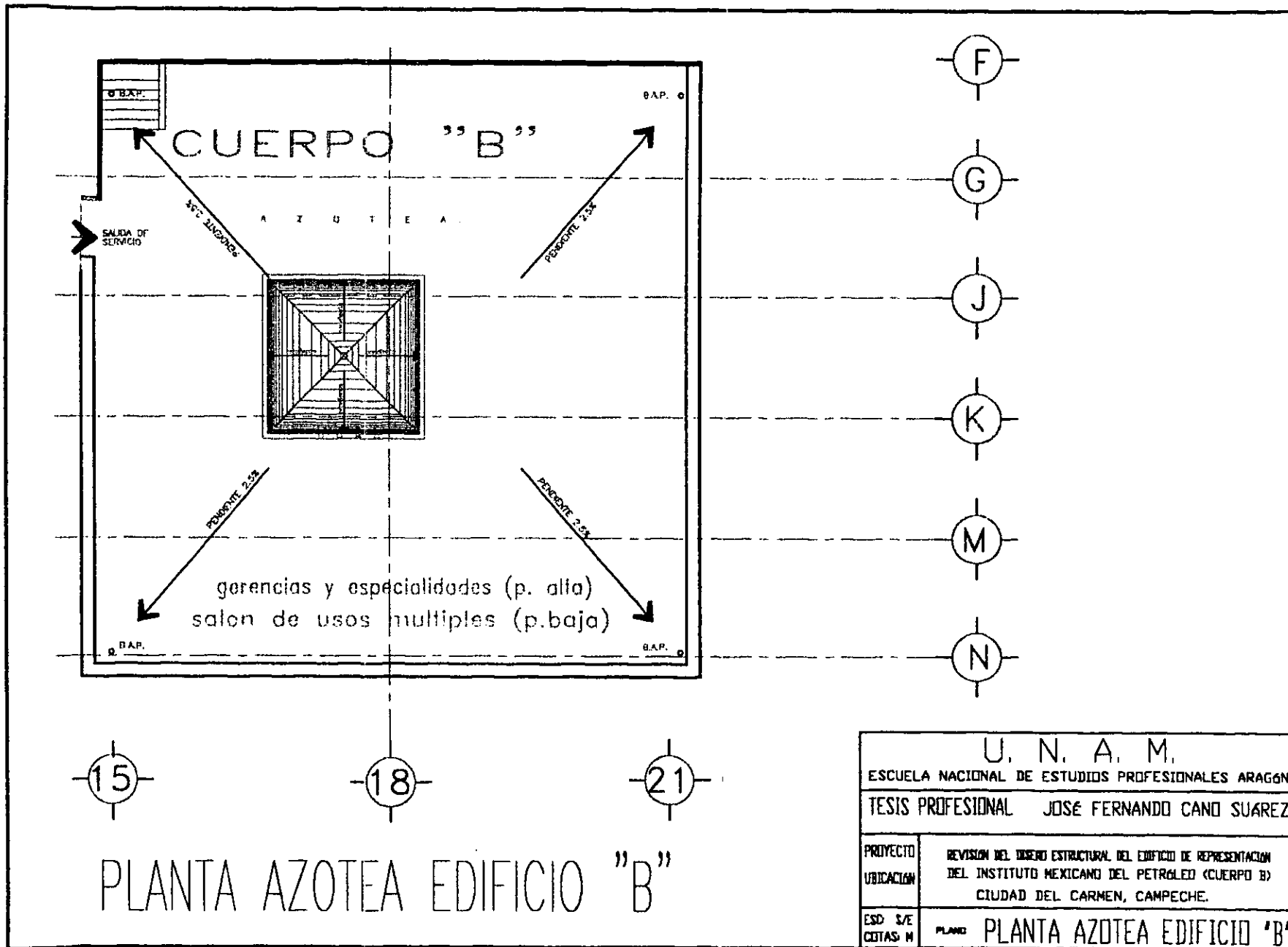

U. N. A. M.	
ESCUELA NACIONAL DE ESTUDIOS PROFESIONALES ARAGÓN	
TESIS PROFESIONAL JOSÉ FERNANDO CANO SUÁREZ	
PROYECTO	REVISIÓN DEL DISEÑO ESTRUCTURAL DEL EDIFICIO DE REPRESENTACIÓN DEL INSTITUTO MEXICANO DEL PETRÓLEO (CUERPO B)
UBICACIÓN	CIUDAD DEL CARMEN, CAMPECHE.
ESD S/E CITAS: M	PLANO PLANTA AZOTEA EDIFICIO "B"

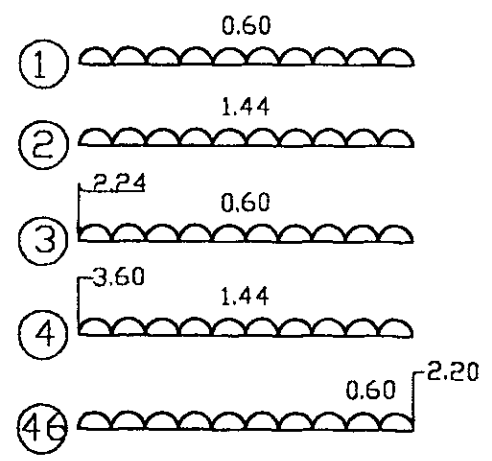
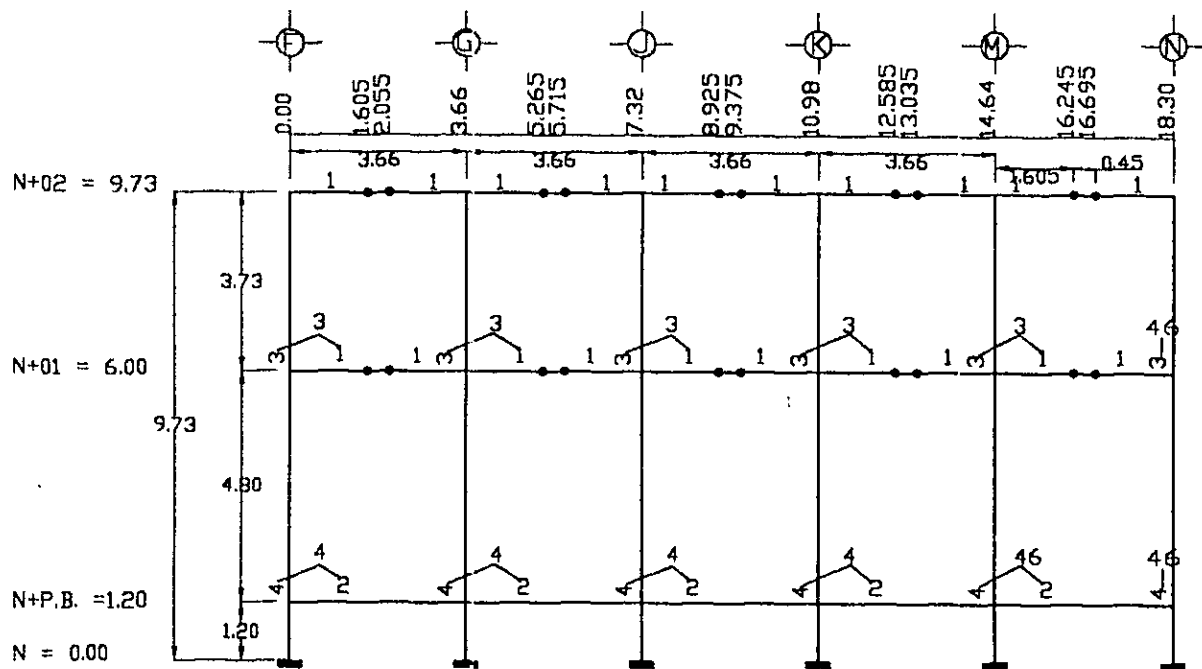

MARCO EJE 15 Y 21
PESO PROPIO DE COLUMNAS

U. N. A. M. ESCUELA NACIONAL DE ESTUDIOS PROFESIONALES ARAGON	
TESIS PROFESIONAL JOSÉ FERNANDO CANO SUÁREZ	
PROYECTO UBICACIÓN	REVISIÓN DEL DISEÑO ESTRUCTURAL DEL EDIFICIO DE REPRESENTACION DEL INSTITUTO MEXICANO DEL PETRÓLEO (CUERPO B) CIUDAD DEL CARMEN, CAMPECHE.
ESO S/E CITAS N	PLANO PESO PROPIO DE COLUMNAS.

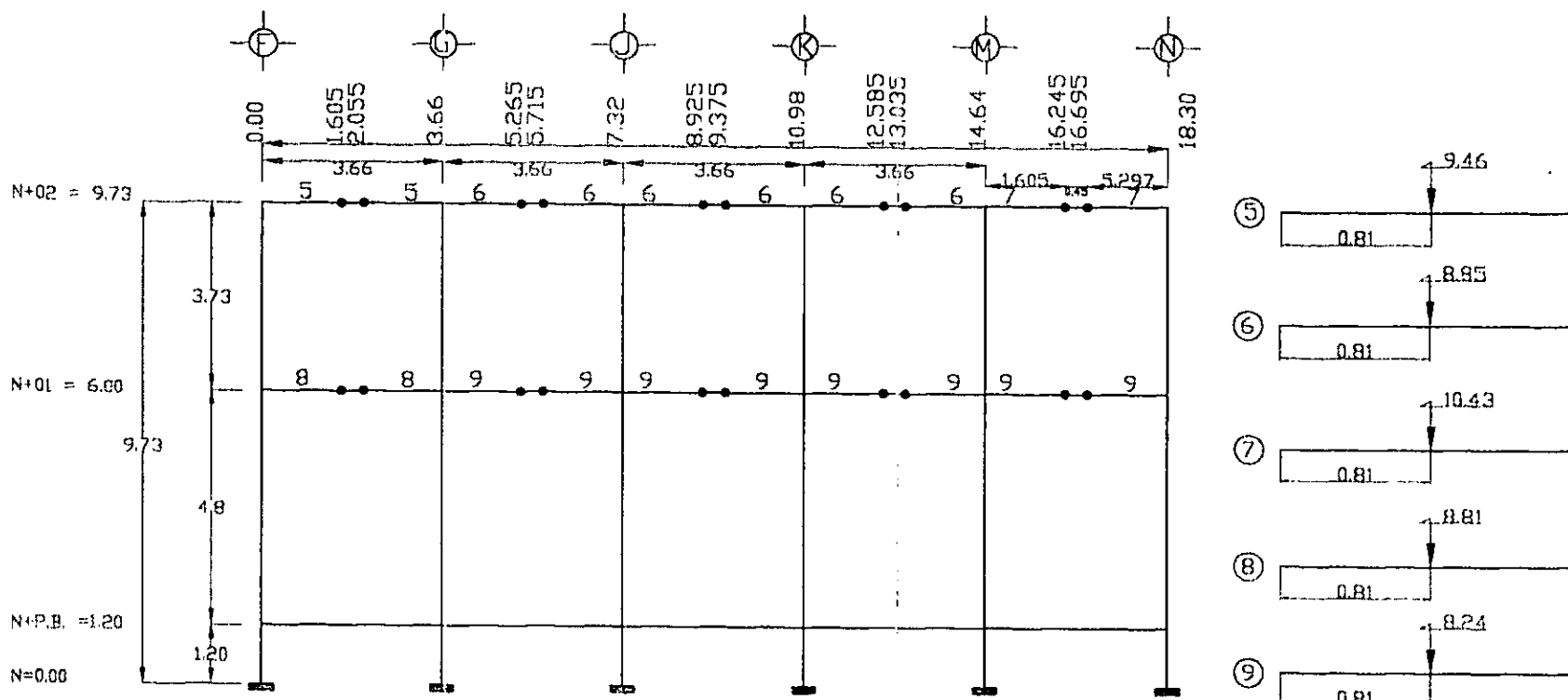

MARCO EJE 15 Y 21

PESO DE TRABES Y FIRME

U. N. A. M.	
ESCUELA NACIONAL DE ESTUDIOS PROFESIONALES ARAGON	
TESIS PROFESIONAL JOSE FERNANDO CAND SUAREZ	
PROYECTO	REVISION DEL DISEÑO ESTRUCTURAL DEL EDIFICIO DE REPRESENTACION
UBICACION	DEL INSTITUTO MEXICANO DEL PETROLEO (CUERPO B) CIUDAD DEL CARMEN, CAMPECHE.
ESO S/E CITAS OI	PLANO PESO DE TRABES Y FIRME

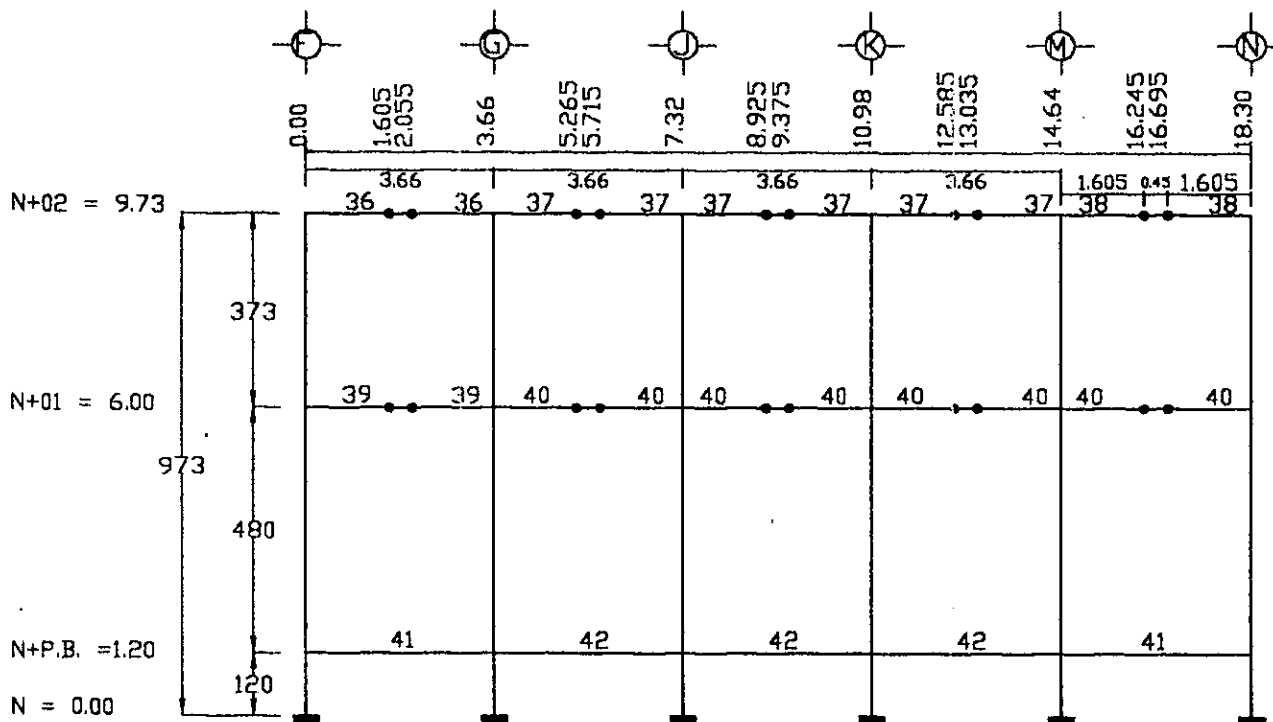

MARCO EJE 15 Y 21 CARGA VIVA ACCIDENTAL

TIPOS DE CARGAS

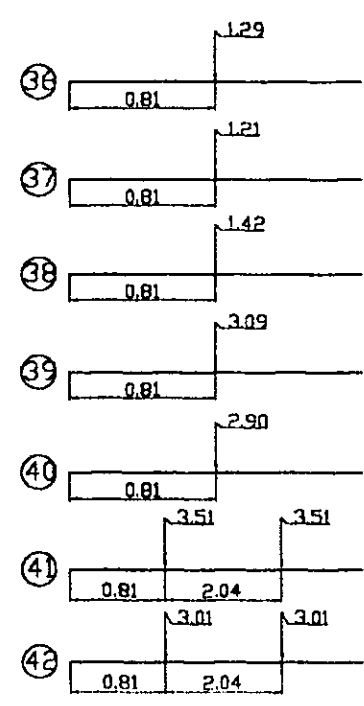

U. N. A. M. ESCUELA NACIONAL DE ESTUDIOS PROFESIONALES ARAGON	
TESIS PROFESIONAL JOSÉ FERNANDO CANO SUAREZ	
PROYECTO UBICACION	REVISION DEL DISEÑO ESTRUCTURAL DEL EDIFICIO DE REPRESENTACION DEL INSTITUTO MEXICANO DEL PETROLEO (CUERPO B) CIUDAD DEL CARMEN, CAMPECHE.
ESD S/E CITAS M	PLANO CARGA VIVA ACCIDENTAL

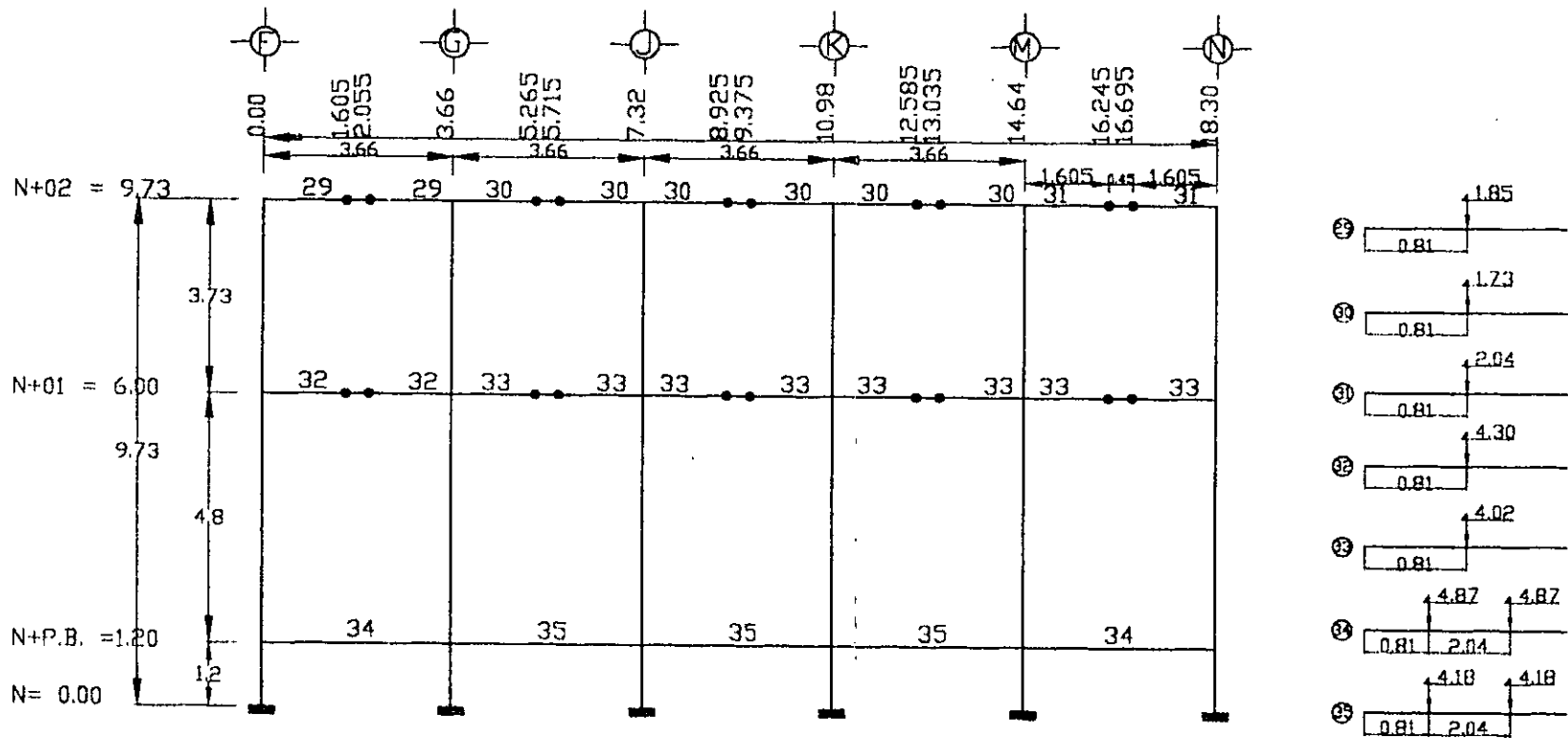

MARCO EJE 15 Y 21

CARGA VIVA MAXIMA

U. N. A. M. ESCUELA NACIONAL DE ESTUDIOS PROFESIONALES ARAGON	
TESIS PROFESIONAL JOSÉ FERNANDO CANDO SUÁREZ	
PROYECTO UBICACION	REVISION DEL DISEÑO ESTRUCTURAL DEL EDIFICIO DE REPRESENTACION DEL INSTITUTO MEXICANO DEL PETRÓLEO (CUERPO B) CIUDAD DEL CARMEN, CAMPECHE.
DISEÑO CITAS II	PLANO CARGA VIVA MAXIMA

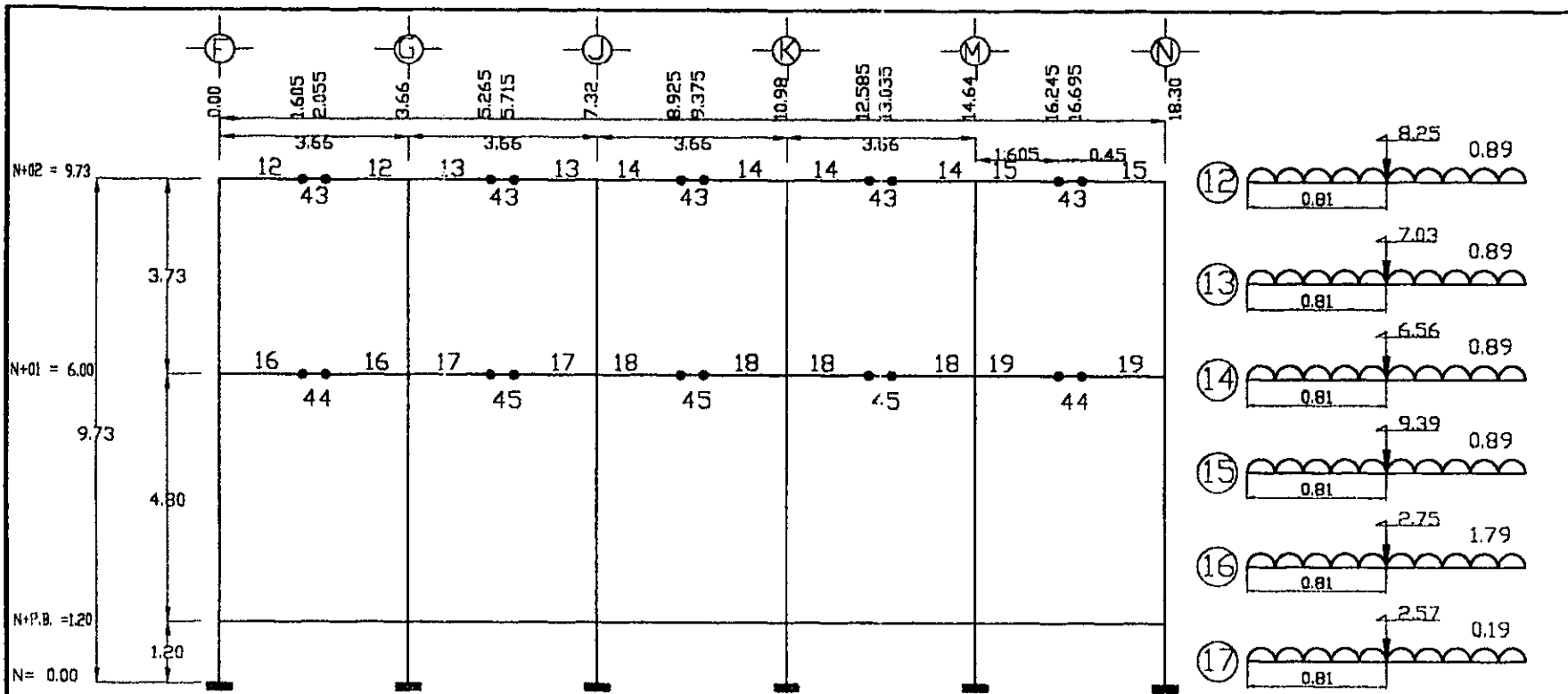

MARCO EJE 15 Y 21 SOBRECARGA MUERTA

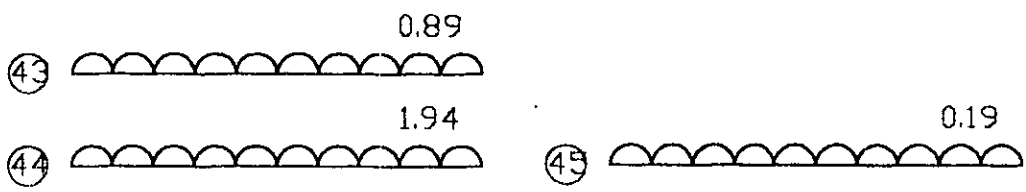
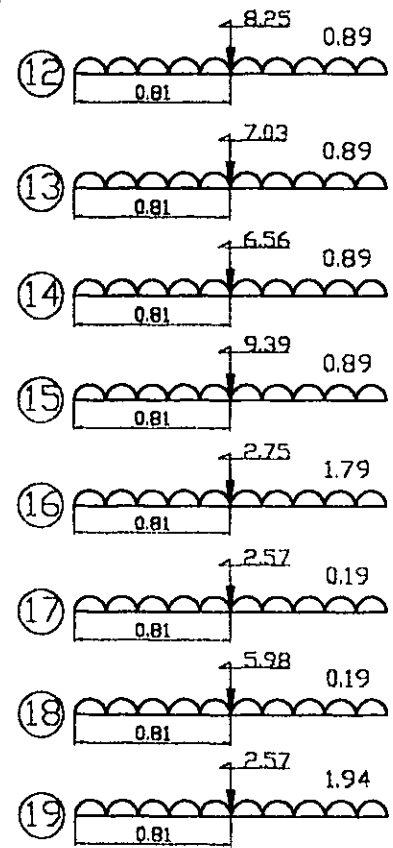

U. N. A. M.	
ESCUELA NACIONAL DE ESTUDIOS PROFESIONALES ARAGON	
TESIS PROFESIONAL JOSE FERNANDO CANO SUAREZ	
PROYECTO	REVISION DEL DISEÑO ESTRUCTURAL DEL EDIFICIO DE REPRESENTACION DEL INSTITUTO MEXICANO DEL PETROLEO (CUERPO B)
UBICACION	CIUDAD DEL CARMEN, CAMPECHE.
ESC. S/E CITAS: N	PLANO SOBRECARGA MUERTA

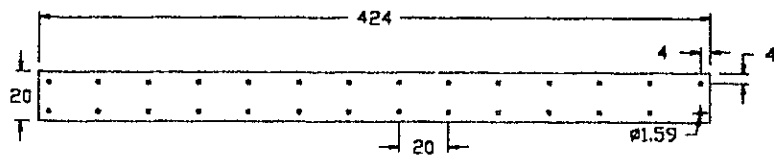

VISTA PLANTA

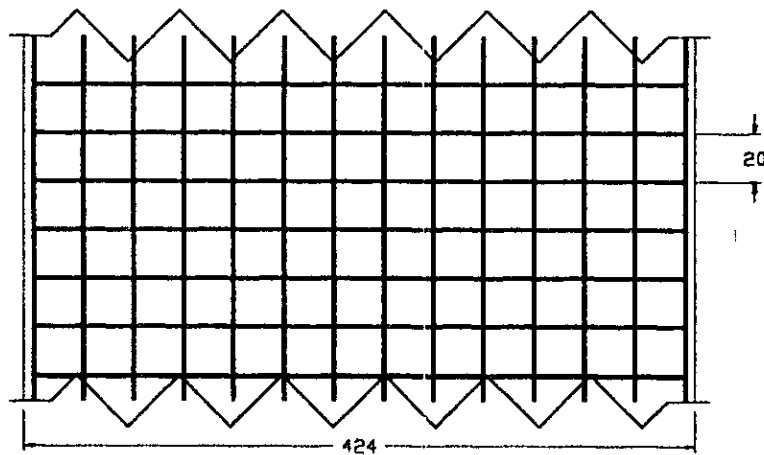

VISTA LATERAL

M U R O 1

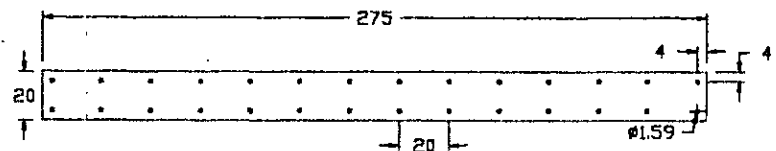

VISTA PLANTA

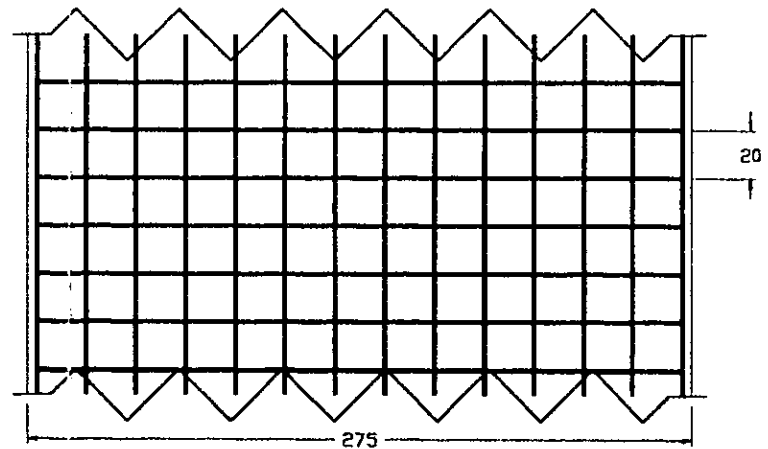

VISTA LATERAL

M U R O 2

U. N. A. M. ESCUELA NACIONAL DE ESTUDIOS PROFESIONALES ARAGÓN	
TESIS PROFESIONAL JOSÉ FERNANDO CANO SUÁREZ	
PROYECTO UBICACIÓN	REVISIÓN DEL DISEÑO ESTRUCTURAL DEL EDIFICIO DE REPRESENTACIÓN DEL INSTITUTO MEXICANO DEL PETRÓLEO (CUERPO B) CIUDAD DEL CARMEN, CAMPECHE.
ESO S/E CUBAS M	PLANO DETALLE DE ARMADOS EN MURD.

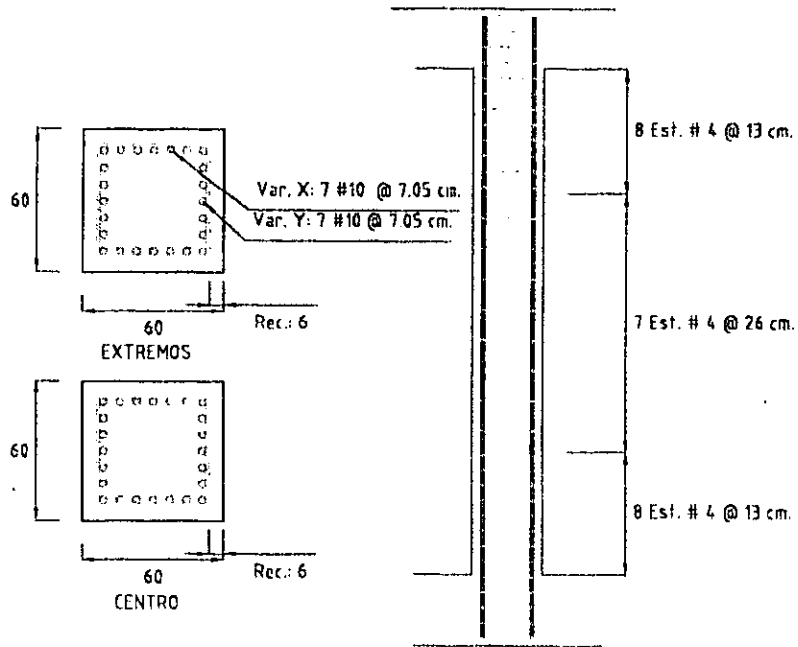

ARMADO DE LAS COLUMNAS DE PLANTA BAJA

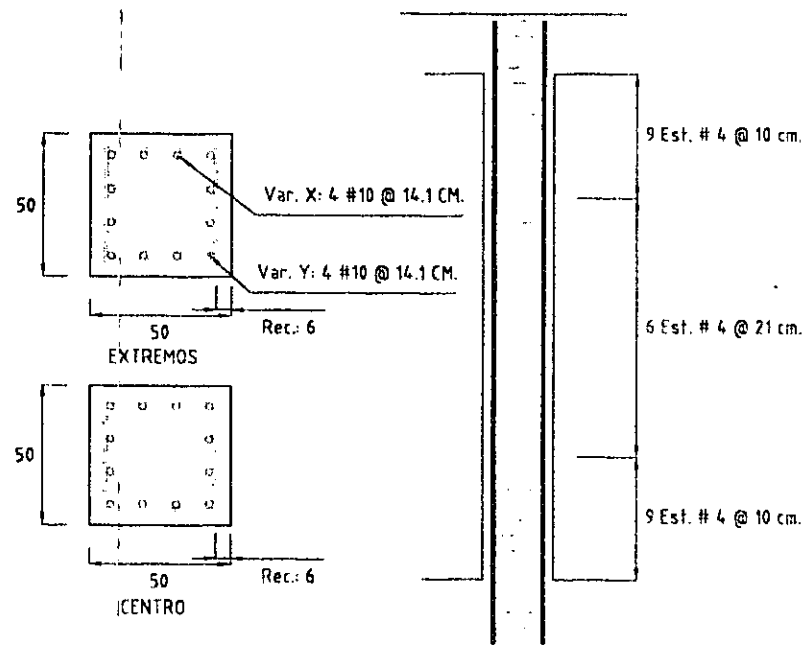

ARMADO DE LAS COLUMNAS DE 1er PISO

U. N. A. M. ESCUELA NACIONAL DE ESTUDIOS PROFESIONALES ARAGÓN	
TESIS PROFESIONAL JOSÉ FERNANDO CANO SUÁREZ	
PROYECTO UBICACIÓN	REVISIÓN DEL DISEÑO ESTRUCTURAL DEL EDIFICIO DE REPRESENTACIÓN DEL INSTITUTO MEXICANO DEL PETRÓLEO (CUERPO B) CIUDAD DEL CARMEN, CAMPECHE.
ESC: S/E COTAS: CH	PLANO ARMADO TIPO DE COLUMNAS

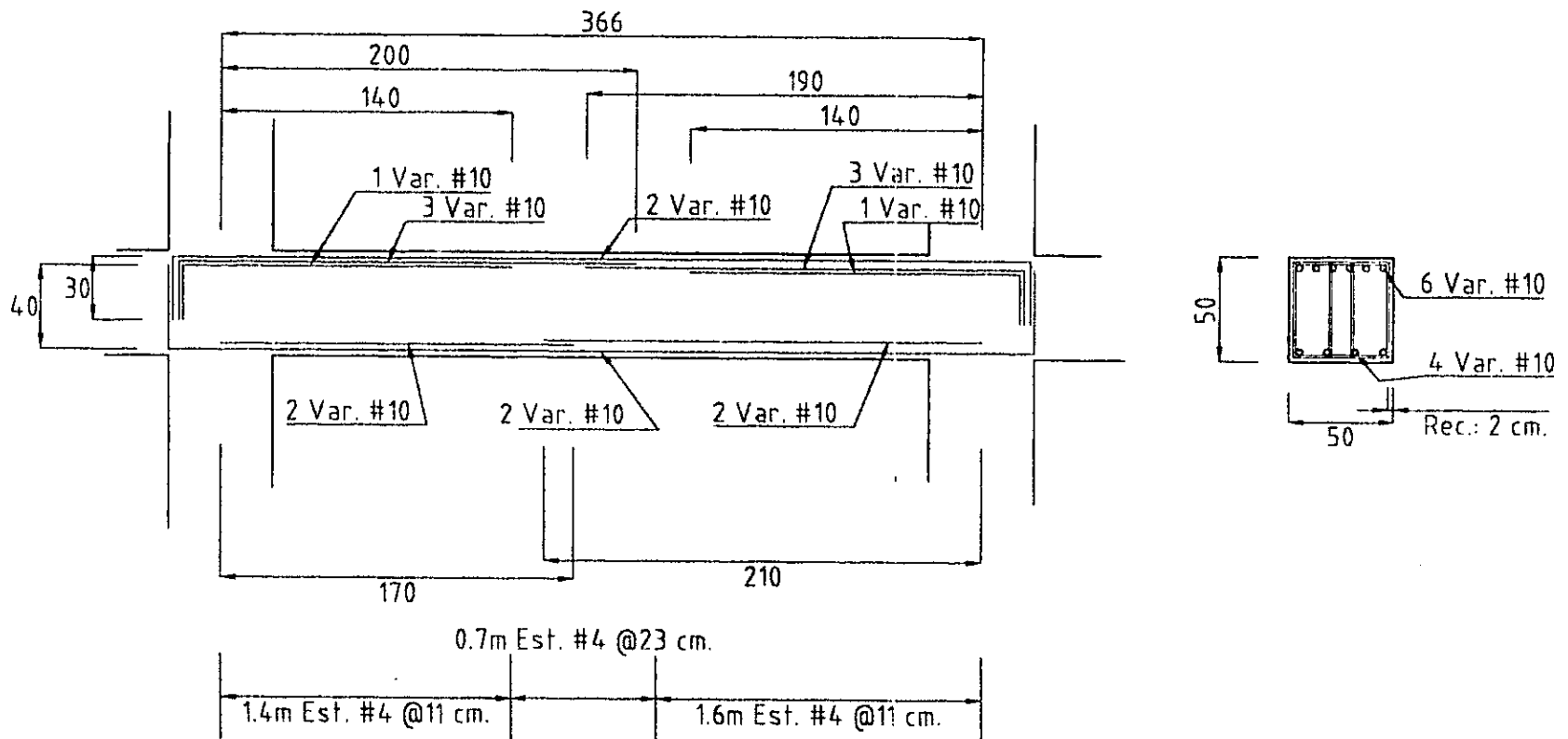

ARMADO DE LAS TRABES DE PLANTA BAJA

U. N. A. M. ESCUELA NACIONAL DE ESTUDIOS PROFESIONALES ARAGÓN	
TESIS PROFESIONAL JOSÉ FERNANDO CANO SUÁREZ	
PROYECTO UBICACIÓN	REVISIÓN DEL DISEÑO ESTRUCTURAL DEL EDIFICIO DE REPRESENTACIÓN DEL INSTITUTO MEXICANO DEL PETRÓLEO (CUERPO B) CIUDAD DEL CARMEN, CAMPECHE.
ESC: S/E COTAS: CH	PLANO ARMADO TIPO DE LAS TRABES DE P.B.

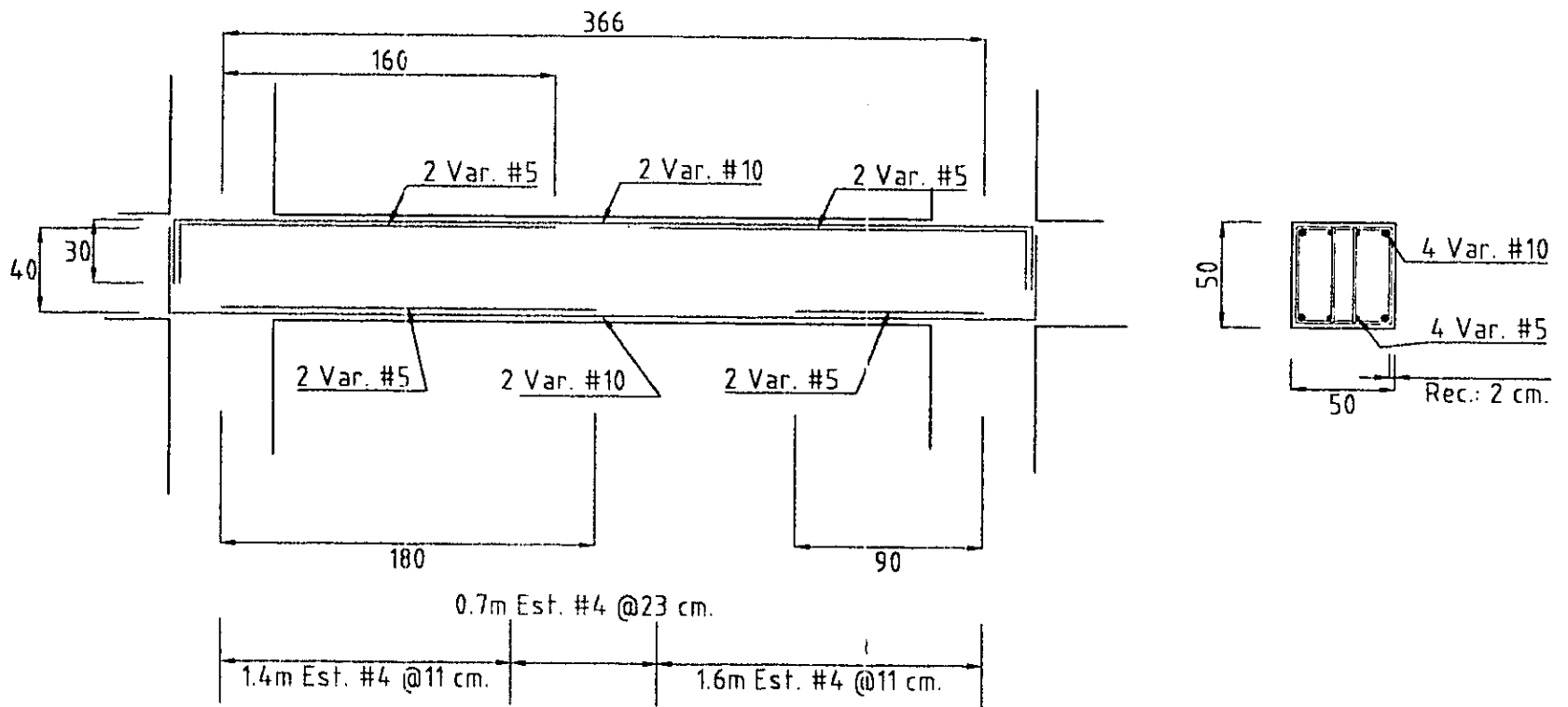

ARMADO DE LAS TRABES DE AZOTEA

U. N. A. M. ESCUELA NACIONAL DE ESTUDIOS PROFESIONALES ARAGÓN	
TESIS PROFESIONAL JOSÉ FERNANDO CANO SUÁREZ	
PROYECTO UBICACIÓN	REVISIÓN DEL DISEÑO ESTRUCTURAL DEL EDIFICIO DE REPRESENTACIÓN DEL INSTITUTO MEXICANO DEL PETRÓLEO (CUERPO B) CIUDAD DEL CARMEN, CAMPECHE.
ESC: S/E COTAS: CN	PLANO ARMADO TIPO DE LAS TRABES DE AZOTEA



BIBLIOGRAFÍA

REGLAMENTO DE CONSTRUCCIONES PARA EL DISTRITO FEDERAL.

DIARIO OFICIAL DE LA FEDERACIÓN

2 DE AGOSTO DE 1993

REGLAMENTO DE CONSTRUCCIONES ACI

1989

**NORMAS TÉCNICAS COMPLEMENTARIAS PARA DISEÑO Y
CONSTRUCCIÓN DE ESTRUCTURAS DE CONCRETO**

**GACETA OFICIAL DEL DEPARTAMENTO DEL DISTRITO FEDERAL, NUM. 48,
MÉXICO D.F. 26 DE NOVIEMBRE DE 1987**

NORMAS TÉCNICAS COMPLEMENTARIAS PARA DISEÑO POR SISMO.

**GACETA OFICIAL DEL DEPARTAMENTO DEL DISTRITO FEDERAL, NUM. 38,
MÉXICO D.F. 5 DE NOVIEMBRE DE 1987**

**MANUAL DE DISEÑO DE OBRAS CIVILES SECCIÓN H: CONCRETO
REFORZADO**





COMISIÓN FEDERAL DE ELECTRICIDAD

MÉXICO 1970

MANUAL AHMSA DE PERFILES ESTRUCTURALES

APLICACIONES DE LA ESTÁTICA

ANTONIO MURRIETA NOCOECHEA LIMUSA, MÉXICO, 1994

MANUAL PARA CONSTRUCTORES ACEROS MONTERREY

**MEMORIAS DE CALCULO PARA EL PROYECTO DE LA REPRESENTACIÓN
DEL INSTITUTO MEXICANO DEL PETRÓLEO CON CEDE EN CD. DEL
CARMEN CAMPECHE.**

RIOBO, MÉXICO SEPTIEMBRE 1997

DISEÑO DE MUROS DE CONCRETO CON FALLA POR CORTANTE

ÓSCAR HERNANDEZ BASILIO

INSTITUTO DE INGENIERÍA, MÉXICO DICIEMBRE 1980

